

KENWOOD

AMPLIFIER-TUNER/CD PLAYER

RD-VH7

CASSETTE TAPE DECK

X-VH7

INSTRUCTION MANUAL

KENWOOD CORPORATION

Before installation, be sure to read "System configuration" and "Installation" in this manual to ensure correct installation.

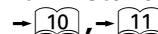

This instruction manual is used to describe multiple models listed above. Model availability and features (functions) may differ depending on the country and sales area.

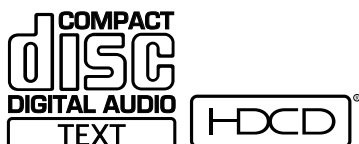

B60-4280-10

EN

2 Before applying power Caution : Read this page carefully to ensure safe operation.

RD-VH7/X-VH7 (EN)

Units are designed for operation as follows.





U.S.A. AC 120 V only

EUROPE & U.K. AC 230 V only

SAFETY

Safety precautions

WARNING : TO PREVENT FIRE OR ELECTRIC SHOCK, DO NOT EXPOSE THIS APPLIANCE TO RAIN OR MOISTURE.

	CAUTION RISK OF ELECTRIC SHOCK DO NOT OPEN		CAUTION: TO REDUCE THE RISK OF ELECTRIC SHOCK, DO NOT REMOVE COVER (OR BACK). NO USER-SERVICEABLE PARTS INSIDE. REFER SERVICING TO QUALIFIED SERVICE PERSONNEL.
	THE LIGHTNING FLASH WITH ARROWHEAD SYMBOL, WITHIN AN EQUILATERAL TRIANGLE, IS INTENDED TO ALERT THE USER TO THE PRESENCE OF UNINSULATED "DANGEROUS VOLTAGE" WITHIN THE PRODUCT'S ENCLOSURE THAT MAY BE OF SUFFICIENT MAGNITUDE TO CONSTITUTE A RISK OF ELECTRIC SHOCK TO PERSONS.		
	THE EXCLAMATION POINT WITHIN AN EQUILATERAL TRIANGLE IS INTENDED TO ALERT THE USER TO THE PRESENCE OF IMPORTANT OPERATING AND MAINTENANCE (SERVICING) INSTRUCTIONS IN THE LITERATURE ACCOMPANYING THE APPLIANCE.		

The marking of products using lasers (Except for some areas)

**CLASS 1
LASER PRODUCT**

The marking is located on the rear panel and says that this product has been classified as Class 1. It means that there is no danger of hazardous radiation outside the product.

CAUTION
INVISIBLE LASER RADIATION
WHEN OPEN. AVOID EXPOSURE
TO BEAM.

Inside of this laser product, a component (a laser diode: Wavelength: 760-800nm) classified as Class 3A laser radiation is contained as alerted by the internal caution label shown above. To avoid exposure to laser beams, do not open the cover.

Contents

Caution : Read the pages marked  carefully to ensure safe operation.

 Before applying power	2
Introduction	6
Special features	7

SAFETY

 IMPORTANT SAFEGUARDS	8
---	---

PREPARATION

System configuration, Installation	10
System configuration	10
Installation	11
System connection	12
Connection of antenna	12
Connection of audio cord	13
Connection of system control cord	14
Connection of speakers	15
Controls and indicators	16
Main Unit	16
Remote control Unit	18
Operation of remote control unit	20
Clock adjustment	21

BASIC OPERATIONS

Hearing sound	22
----------------------------	----

CD OPERATIONS

Playback of CD	26
Recording a HDCD disc	29
Listening in the desired sequence (program playback)	30
Repeated playback	32
Playing tracks in a random order (random playback)	33

TUNER OPERATIONS

Receiving broadcast station	34
Selecting a preset station (Preset call)	34
Manual tuning and preset operation	35
Using R.D.S. (Radio Data System) (For U.K. and Europe)	36
Searching for a desired program type (PTY search)	37
To be able to listen to the desired information at any time (EON reservation)	38

CASSETTE DECK OPERATIONS

Playback of tape	40
DPSS (Direct Program Search System)	42
Recording onto cassette tape	44
Recording CD tracks in the desired sequence (Program recording)	47
Recording only desired tracks (ONE TOUCH EDIT.....single track recording)	48
One-touch recording of an entire CD (ONE TOUCH EDIT.....recording of all tracks)	49

TIMER OPERATIONS

Timer operation	50
O.T.T. Timer	50
Program timer playback (AI timer playback) and timer recording	51
Sleep timer	54

REFERENCE INFORMATION

Important Items	55
Handling of discs and tapes	55
Precautions and Notes	57
In case of difficulty	58
Specifications	62

Demonstration

The demonstration consists of sequential switching of display for showing the functions available with the system.

The audio does not change while the demonstration is active.

Demonstration cannot be started during playback (or recording) of a source.

- Provided that the power is set to ON, demonstration is switched automatically to "DEMO ON" after there is a power failure or the power cord is unplugged then plugged in again.

DEMO ON (Demonstration executed):

While the power is set to ON, press and hold the "auto/mono, demo" key on the amplifier-tuner/CD player for more than 2 seconds.

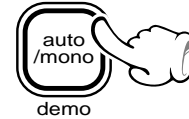

DEMO OFF (Demonstration cancelled):

- Press the "auto/mono, demo" key in the "DEMO ON" mode.

Accessories

Accessories supplied with RD-VH7

AM loop antenna (1)

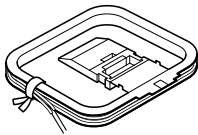

FM indoor antenna (1)

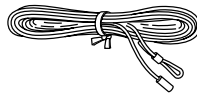

Replacement front feet (2)



Remote control unit (1)

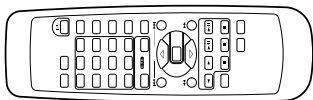

Batteries (R6/AA) (2)

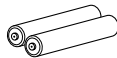

Front feet replacement tool (Allen wrench) (1)



Accessories supplied with X-VH7 (optional)

System control cord (1)

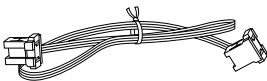

Audio cord (2)

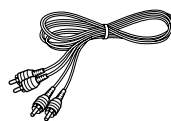

Spacer for stacked installation (1)

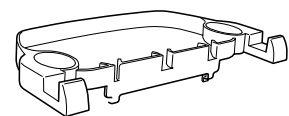

Front feet replacement tool (Allen wrench) (1)



Replacement front feet (2)



Note on the instruction manuals

Among the VH series models, some are provided with a system instruction manual describing both the RD-VH7 (amplifier-tuner/ CD player) and X-VH7 (cassette deck) while some are provided with an independent instruction manual describing only the purchased model. This is intended to facilitate each purchaser perform system operations any time if he or she purchases other separately available system components later. Please read the information related only to the model you purchased if the manual provided with it contains information on other models.

For the DM-VH7 (MD recorder) in the VH series, only the connection method is described in the system instruction manual. For details on the DM-VH7, please refer to the independent instruction manual provided with it.

Model (Purchased model)	Provided Manual (Models described in it)
Amplifier-tuner/CD player (RD-VH7)	System instruction manual (RD-VH7, X-VH7)
Cassette deck (X-VH7)	Independent instruction manual (X-VH7)
MD recorder (DM-VH7)	Independent instruction manual (DM-VH7)



Unpacking

Unpack the unit carefully and make sure that all accessories are put aside so they will not be lost.

Examine the unit for any possibility of shipping damage. If your unit is damaged or fails to operate, notify your dealer immediately. If your unit was shipped to you directly, notify the shipping company without delay. Only the consignee (the person or company receiving the unit) can file a claim against the carrier for shipping damage.

We recommend that you retain the original carton and packing materials for use should you transport or ship the unit in the future.

Keep this manual handy for future reference.

VH series

Thank you for purchasing an VH series product.

The VH series system components include the amplifier-tuner/ CD player, MD recorder and cassette deck, so the user can select and purchase desired models among them.

By connecting some of these components using KENWOOD system control cords, convenient system operations will be available as described below.

Remote control

The basic operations of the source components (cassette deck, MD recorder) can be controlled from the remote control unit provided with the amplifier-tuner/ CD player.

Automatic operation

When an input source is selected on the amplifier-tuner/ CD player, the source component of the newly selected source (CD player, MD recorder, cassette deck, tuner) starts playback automatically.

Synchronized recording

When recording audio of a CD or MD onto a cassette, the recording of the cassette deck can be started automatically in synchronism with the start of playback of the source component.

Timer operations

The recording or playback of a source component (CD player, cassette deck, MD recorder, tuner) can be started automatically using the timer built into the amplifier-tuner/ CD player.

VH series components

RD-VH7 (Amplifier-tuner/ CD player)

DM-VH7 (MD recorder)

X-VH7 (Cassette deck)

Note on installation

Be sure to read "System configuration" (page 10) and "Installation" (page 11) before installing the system.

Special features

❑ **Amplifier designed with emphasis on sound quality (Pure A amplification)**

The Pure A class reproduction mode is built in to improve the sound quality during low-level listening. The sound quality is switched automatically into AB-class as the volume level is decreased to ensure transparent, clear sound at all levels.

❑ **Free layout**

The system components can be installed vertically on the sides (lengthwise) as well as the conventional, horizontally stacked installation. Much flexible system setting than before is now possible.

❑ **LCD (Liquid Crystal Display) with backlit illumination**

A high-definition graphic display on each component shows the operating modes such as CD playback and tuner reception conditions at a glance. The display orientation can be changed according to whether the system components are installed vertically or stacked horizontally.

❑ **CD player with HDCD (High-Definition Compatible Digital recording) compatibility**

CDs recorded in the HDCD format can be played back with higher resolution and wider dynamic range. CDs recorded in the normal format can naturally be played back more delicately than before.

", HDCD®, High Definition Compatible Digital® and Pacific Microsonics™ are either registered trademarks or trademarks of Pacific Microsonics, Inc. in the United States and/or other countries."

❑ **CD-TEXT data display**

The text data (disc title, track titles) recorded in CDs can be displayed on the LCD.

❑ **R.D.S. (Radio Data System) (For U.K. and Europe)**

The RDS data included in FM broadcasts can be used to search for the intended broadcasting contents and for automatic reception from standby.

❑ **One-touch operation playback**

Even when the power is set to OFF (standby), simply pressing the play key on the front panel of the CD player, MD recorder or tape deck or the "**band**" key of the tuner starts playback of the corresponding source component immediately.

❑ **Convenient timer functions**

① **O.T.T. timer :**

When the set time comes, a source starts to play automatically only for an hour.

② **Program timer for playback (AI timer playback) and timer recording:**

Two timer programs (PROG.1 and PROG.2) are available for each of the timer playback (AI timer playback) and timer recording functions. (When playback is started with the AI timer, the volume increases automatically until the specified level.)

③ **Sleep timer :**

When the set time comes, the power of the system is set automatically to OFF (standby). This is convenient for example when you want to fall asleep while listening to music.

Please read all of the safety and operating instructions before operating this appliance. Adhere to all warnings on the appliance and in the instruction manual. Follow all the safety and operating instructions. These safety and operating instructions should be retained for future reference.

1. **Power sources** – The appliance should be connected to a power supply only of the type described in the instruction manual or as marked on the appliance. If you are not sure of the type of power supply to your home, consult your appliance dealer or local power company. For appliances intended to operate from battery power, or other sources, refer to the instruction manual.
2. **Power-cord protection** – Power-supply cords should be routed so that they are not likely to be walked on or pinched by items placed upon or against them, pay particular attention to cords at plugs, convenience receptacles, and the point where they exit from the appliance.

Never pull or stretch the cord.
3. **CAUTION – Polarization** – This appliance may be equipped with a polarized alternating-current line plug (a plug having one blade wider than the other). This plug will fit into the power outlet only one way. This is a safety feature. If you are unable to insert the plug fully into the outlet, try reversing the plug. If the plug should still fail to fit, contact your electrician to replace your obsolete outlet. Do not defeat the safety purpose of the polarized plug.
4. **Ventilation** – Slots and openings in the cabinet are provided for ventilation and to ensure reliable operation of the appliance and to protect it from overheating, and these openings must not be blocked or covered. The appliance should be situated so that its location or position does not interfere with its proper ventilation. To maintain good ventilation, do not put records or a tablecloth on the appliance. Place the appliance at least 10 cm away from the walls. Do not use the appliance on a bed, sofa, rug or similar surface that may block the ventilation openings. This appliance should not be placed in a built-in installation such as a bookcase or rack unless proper ventilation is provided or the manufacturer's instructions have been adhered to.
5. **Water and moisture** – The appliance should not be used near water - for example, near a bathtub, wash-bowl, kitchen sink, laundry tub, in a wet basement, or near a swimming pool, etc.
6. **Temperature** – The appliance may not function properly if used at extremely low, or freezing temperatures. The ideal ambient temperature is above +5°C (41°F).
7. **Heat** – The appliance should be situated away from heat sources such as radiators, heat registers, stoves, or other appliances (including amplifiers) that produce heat.
8. **Electric shock** – Care should be taken so that objects do not fall and liquid is not spilled into the enclosure through openings. If a metal objects, such as a hair pin or a needle, comes into contact with the inside of this appliance, a dangerous electric shock may result. For families with children, never permit children to put anything, especially metal, inside this appliance.
9. **Enclosure removal** – Never remove the enclosure. If the internal parts are touched accidentally, a serious electric shock might occur.
10. **Magnetic fields** – Keep the appliance away from sources of magnetic fields such as TV sets, speaker systems, radios, motorized toys or magnetized objects.
11. **Cleaning** – Unplug this appliance from the wall outlet before cleaning. Do not use volatile solvents such as alcohol, paint thinner, gasoline, or benzine, etc. to clean the cabinet. Use a clean dry cloth.
12. **Accessories** – Do not place this appliance on an unstable cart, stand, tripod, bracket, or table. The appliance may fall, causing serious injury to a child or adult, and serious damage to the appliance. Use only with a cart, stand, tripod, bracket, or table recommended by the manufacturer, or sold with the appliance. Any mounting of the appliance should follow the manufacturer's instructions, and should use a mounting accessory recommended by the manufacturer. An appliance and cart combination should be moved with care. Quick stops, excessive force, and uneven surfaces may cause the appliance and cart combination to overturn.
13. **Lightning** – For added protection for this appliance during a lightning storm, or when it is left unattended and unused for long periods of time, unplug it from the wall outlet and disconnect the antenna or cable system. This will prevent damage to the appliance due to lightning and power-line surges.

14. Abnormal smell – If an abnormal smell or smoke is detected, immediately turn the power OFF and unplug the appliance from the wall outlet. Contact your dealer or nearest service center.

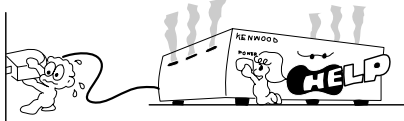

15. Damage requiring service – The appliance should be serviced by qualified service personnel when:

- A. The power-supply cord or the plug has been damaged.
- B. Objects have fallen, or liquid has been spilled into the appliance.
- C. The appliance has been exposed to rain or water.
- D. The appliance does not appear to operate normally by following the instruction manual. Adjust only those controls that are covered by the instruction manual as an improper adjustment of other controls may result in damage and will often require extensive work by a qualified technician to restore the appliance to its normal operation.
- E. The appliance has been dropped, or the enclosure damaged.
- F. The appliance exhibits a marked change in performance.

16. Servicing – The user should not attempt to service the appliance beyond that described in the instruction manual. All other servicing should be referred to qualified service personnel.

17. Outdoor antenna grounding – If an outside antenna is connected to the appliance, be sure the antenna system is grounded so as to provide some protection against voltage surges and built up static charges. Article 810 of the National Electrical Code ANSI/ NFPA 70, provides information with respect to proper grounding of the mast and supporting structure, grounding of the lead-in wire to an antenna discharge unit, size of grounding conductors, location of antenna discharge unit, connection to grounding electrodes, and requirements for the grounding electrode. See Figure.

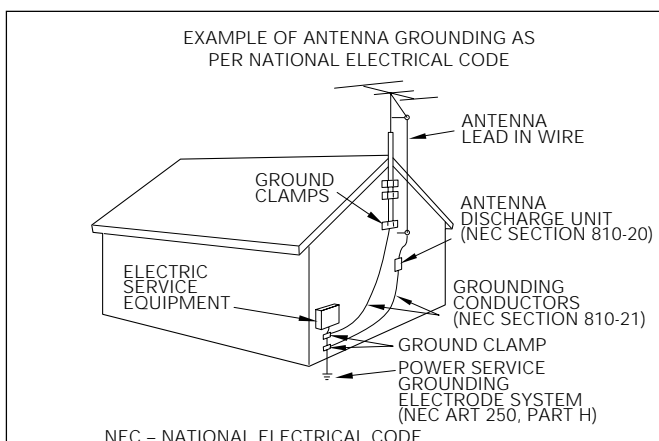

18. Power lines – An outside antenna system should not be located in the vicinity of overhead power lines or other electric light or power circuits, or where it can fall into such power lines or circuits. When installing an outside antenna system, extreme care should be taken to keep from touching such power lines or circuits as contact with them might be fatal.

19. AC outlets – Do not connect other audio equipment with a power consumption larger than that specified to the AC outlet on the rear panel. Never connect other electrical appliances, such as an iron or toaster, to it to prevent fire or electric shock.

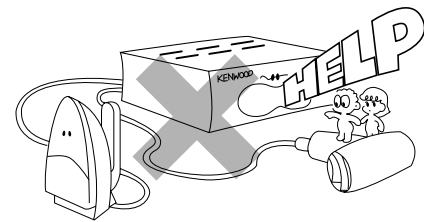

20. Overloading – Do not overload wall outlets, extension cords, or integral convenience receptacles as this can result in a risk of fire or electric shock.

21. Attachment – Do not use attachments not recommended by the appliance manufacturer as they may cause hazards.

22. Replacement parts – When replacement parts are required, be sure the service technician has used replacement parts specified by the manufacturer or have the same characteristics as the original parts. Unauthorized substitutions may result in fire, electric shock, or other hazards.

23. Safety check – Upon completion of any service or repairs to this appliance, ask the service technician to perform safety checks to determine that the appliance is in proper operating condition.

Notes:

- 1. Item 3 is not required except for grounded or polarized equipment.
- 2. Item 17 and 18 are not required except for units provided with antenna terminals.
- 3. Item 17 complies with UL in the U.S.A.

System configuration

The VH series system components can be installed either vertically on the sides (lengthwise) or horizontally by stacking one component on another. If you purchased the RD-VH7 alone, install it properly by also referring to the instruction manuals of the components to which it is connected.

RD-VH7 + DM-VH7+ X-VH7 (Amplifier-tuner/ CD player, MD recorder, Cassette deck)

(Horizontally stacked installation)

PREPARATION

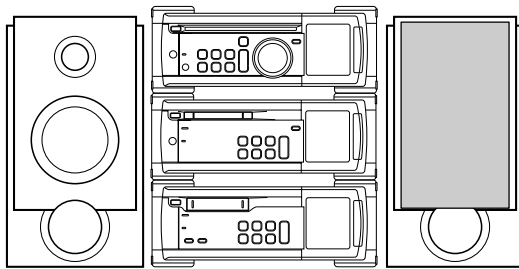

(Layout)

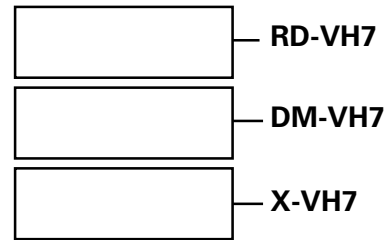

With the horizontally stacked installation, be sure to use the provided spacer. → 11

(Vertical, lengthwise installation)

Place each component so that its LCD comes at the bottom as shown in the illustration.

Be sure to change the feet before vertical installation. → 11

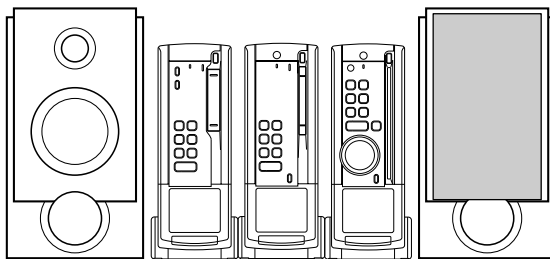

(Layout)

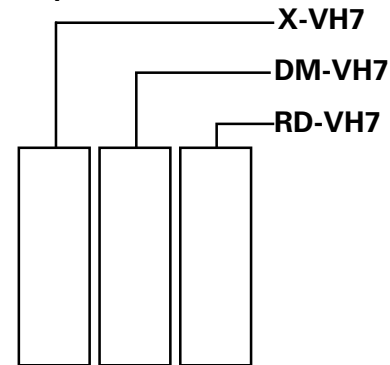

CAUTION Caution for Installation

To prevent fire hazard due to overheating, be sure to observe the information on this page when installing components horizontally by stacking them.

- The RD-VH7 incorporates a ventilation fan and should always be stacked on the top of other components.
- To avoid blocking heat radiation from the RD-VH7, do not place any object above it or behind the ventilation hole on the rear panel.

Top : 50 cm Back panel : 10 cm



- Before changing the installation layout, be sure to take out the CD, MD and cassette tape from the system components and unplug the power cords.
- Be careful not to tilt down the system components by mistake. Otherwise the CD, MD and/or cassette tape left in them may be damaged.

Installation

When the components are to be installed horizontally for stacking, be sure to use the spacer for stacked installation which is provided with each component unit.

The front feet attached at the factory to each component unit of this series can be replaced with the provided replacement feet.

Installation accessories and installation precautions

Replacement front feet 2 with each unit
 Spacer for stacked installation
 1 with DM-VH7 and X-VH7
 Allen wrench 1 with each unit



- Only the front feet can be replaced.
- When attaching replacement front feet, use only the screws which have been used with the removed feet. (Using other screws may result in a fire or malfunction.)
- Eject the CD, MD and/or tape and unplug the power cord before installation.

Changing the installation method

Horizontal, stacked installation

Use the provided spacer for horizontal installation.

- 1 Attach the spacer by inserting its claws into the spacer mount holes on the rear of the DM-VH7/X-VH7.

CAUTION When inserting the claws, align them with the holes by tilting the spacer slightly (about 20 degrees) as shown in the illustration.

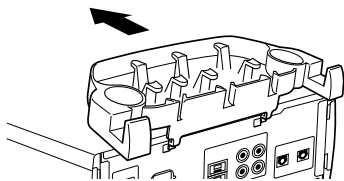

- 2 Arrange the cords by winding them around the spacer.

The audio cords and system control cord can be accommodated into the trench on the spacer by winding them as shown in the illustration.

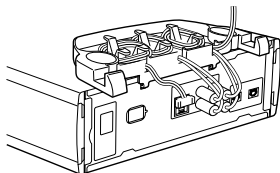

- 3 Stack the component on this unit by aligning the feet of the upper component with the foot support cavities on the spacer.

Vertical installation

Change the left front foot location as described below.

- 1 Using the Allen wrench, remove the 2 screws from the front foot located on the left when the unit is seen from the front.
- 2 Align the removed front foot with the threaded holes on the rear part of the right side panel, and attach the front foot using the screws removed in step 1.

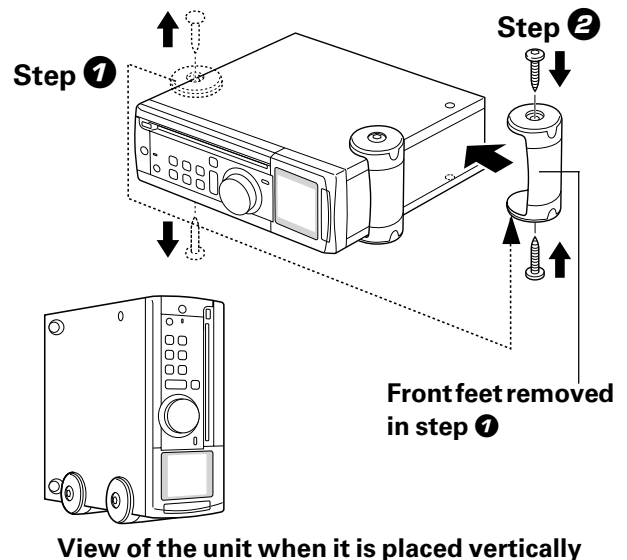

How to replace the front feet

The factory-attached front feet can be exchanged with the provided replacement front feet.

- 1 Using the Allen wrench, remove the 4 screws from each front foot.
- 2 Attach the provided replacement front feet. Attach using two of the 4 screws removed in step 1.

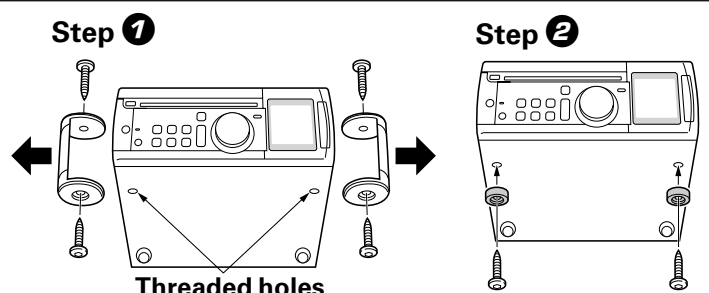

1. Connection of antenna

Connect the antenna as shown in the figure.

Do not plug the power cord into a wall AC outlet until the connection has been completed.

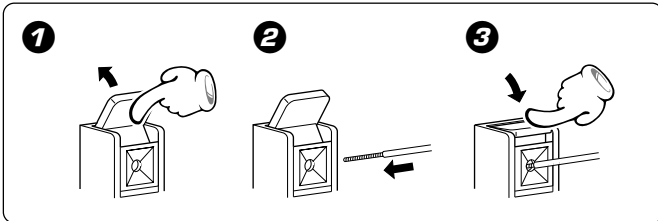

PREPARATION

Connection of the Accessory Antenna

AM loop antenna

The supplied antenna is for indoor use. Place it as far as possible from the main system, TV set, speaker cords and power cord, and set it to a direction which provides the best reception.

FM indoor antenna

The accessory antenna is for temporary indoor use only. For stable signal reception we recommend using an outdoor antenna. Remove the indoor antenna if you connect one outdoors.

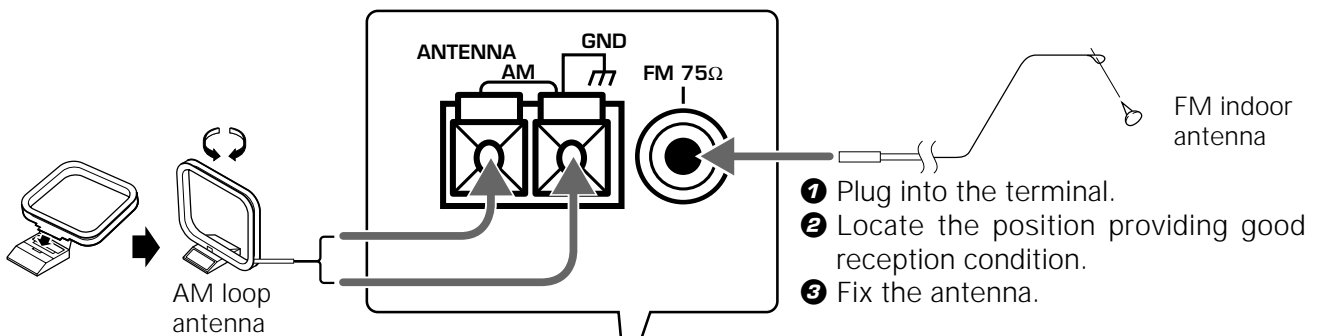

In case of bad reception

FM outdoor antenna

Lead the 75Ω coaxial cable connected to the FM outdoor antenna into the room and connect it to the FM 75Ω terminal.

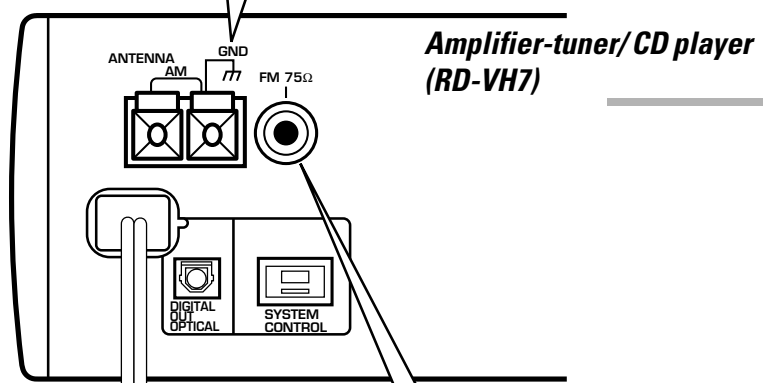
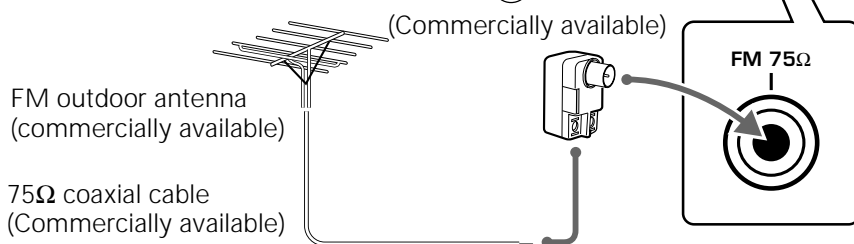

Amplifier-tuner/ CD player (RD-VH7)

2. Connection of audio cord

Here, connection of separately sold components also will be explained under consideration of system connection. Please install correctly according to the purchased components and connect the required cords.

Caution for Connection

When connections are to be made, make sure that the power plug is not plugged into a wall AC outlet. Connect the equipment as shown in the figures.

Malfunction of microcomputer

If operation is not possible or erroneous display appears even though all connections have been made properly, reset the microcomputer referring to "In case of difficulty". → 58

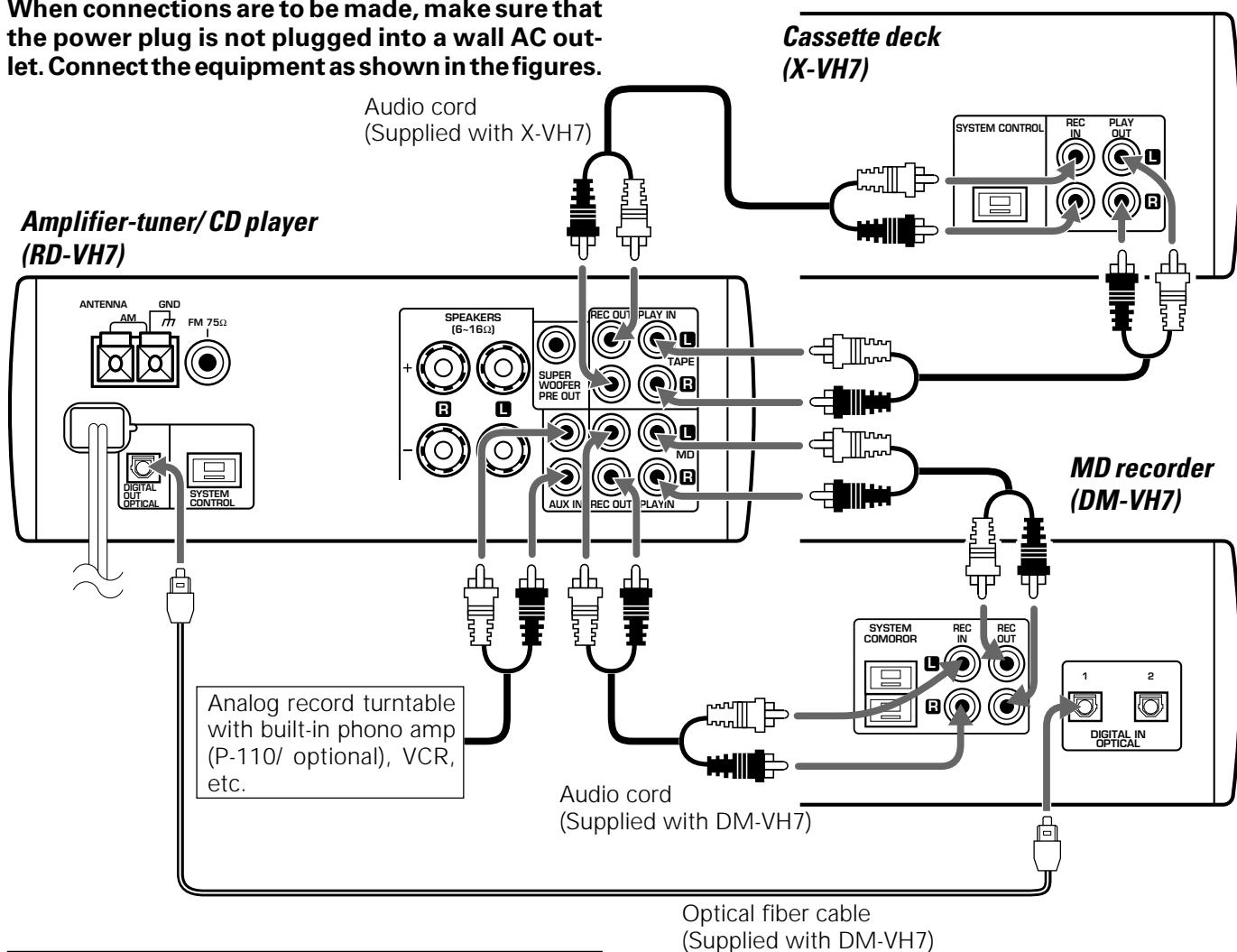

PREPARATION

Connection with Optical Fiber Cable

RD-VH7

DM-VH7

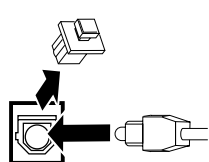
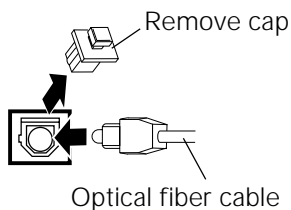

This is used for digital connections. Digital transmission permits recording without loss of the high CD sound quality.

Remove the cap and connect an optical fiber cable.



1. In case an associated system component is connected, also read the instruction manual of the component.
2. Insert the optical-fiber cable straight into the connector until it clicks.
3. Be sure to attach the protection cap when the connector is not used.
4. Be careful not to bend, coil or bundle the optical fiber cable.

3. Connection of system control cord

Caution for Connection

When connections are to be made, make sure that the power plug is not plugged into a wall AC outlet. Connect the equipment as shown in the figures.

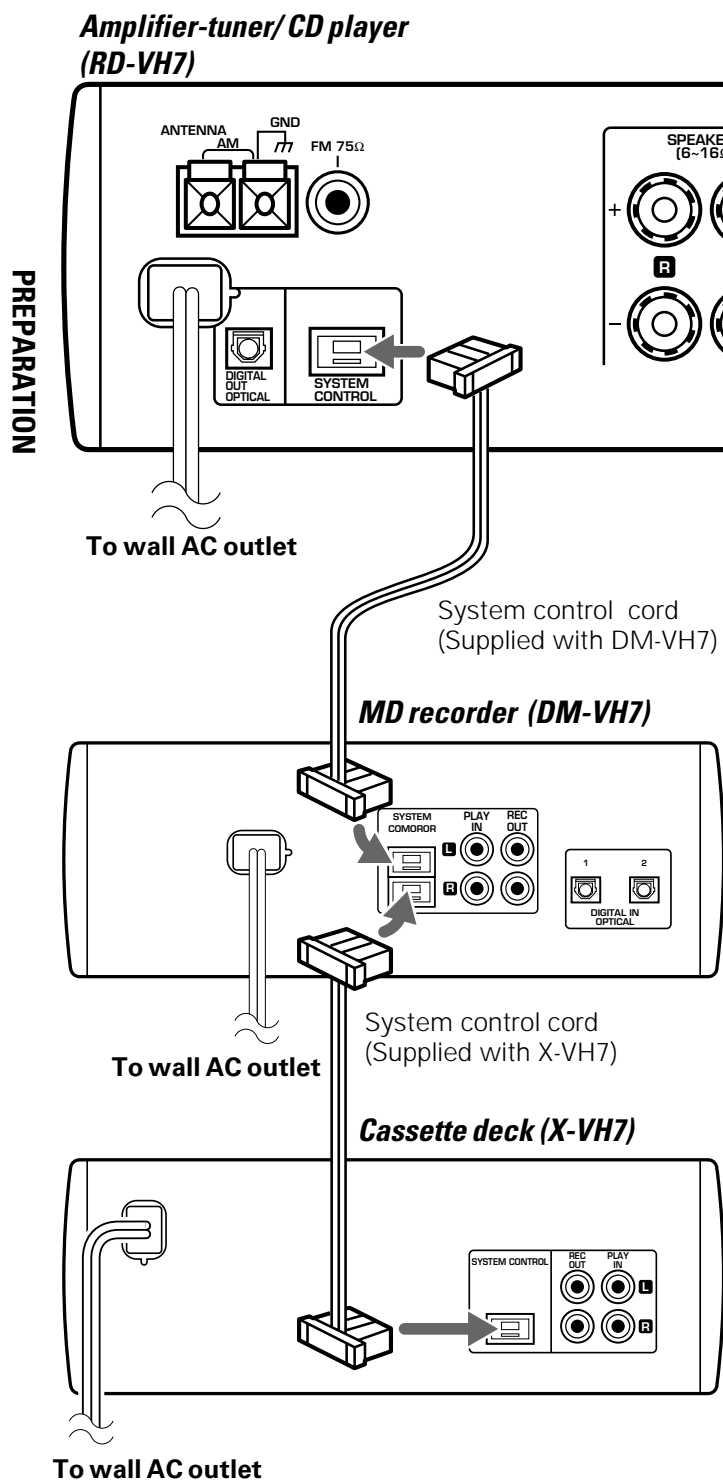

Connection of system control cord

Plugging the connector

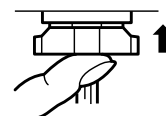

Insert straight until it clicks and locks.

Unplugging the connector

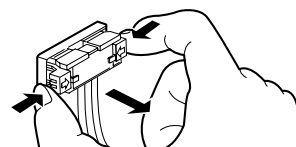

Push both ends of the connector to unlock it then pull it straight out.



1. Be sure to insert all connection cords securely. If their connections are imperfect, the sound may not be produced or noise may interfere.
2. Before plugging or unplugging a connection cord, be sure to unplug the power cord from the wall AC outlet. If connection cords are plugged or unplugged with the power cord left plugged in, malfunction or damage may result.

4. Connection of speakers

Connect the speakers as shown in the figure.

Do not plug the power cord into a wall AC outlet until the connection has been completed.

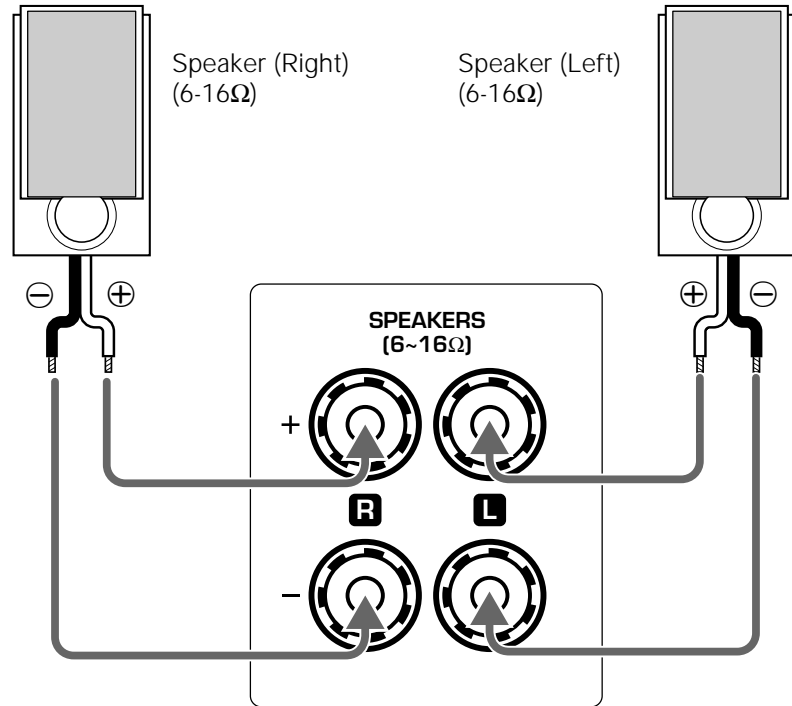
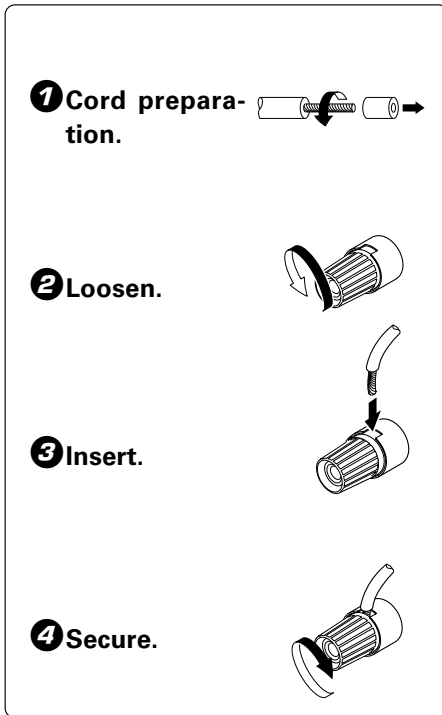

Amplifier-tuner/ CD player (RD-VH7)

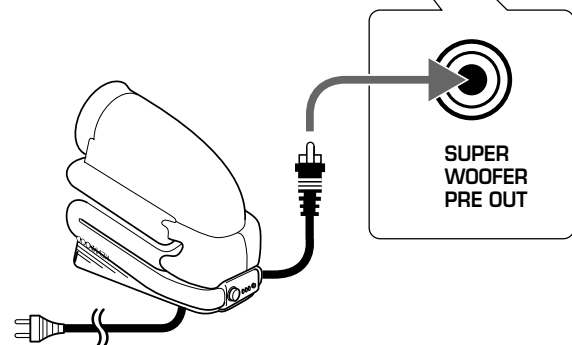
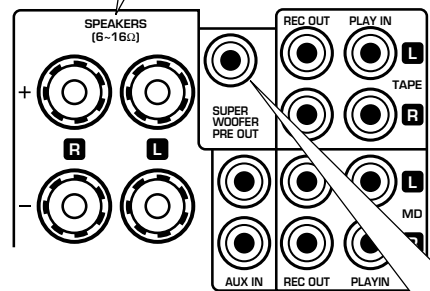

- Never short-circuit the + and - speaker cords. The protection circuit will operate and no sound will be put out.
- If the left and right speaker connections or the + and - polarity are inverted, the sound will be unnatural with unclear localization of musical instruments, etc. Be sure to connect them without mistake.

Super woofer (SW-500) (optional)

Extremely low frequency sound is played back powerfully.

Main Unit

Amplifier-tuner/CD player (RD-VH7)

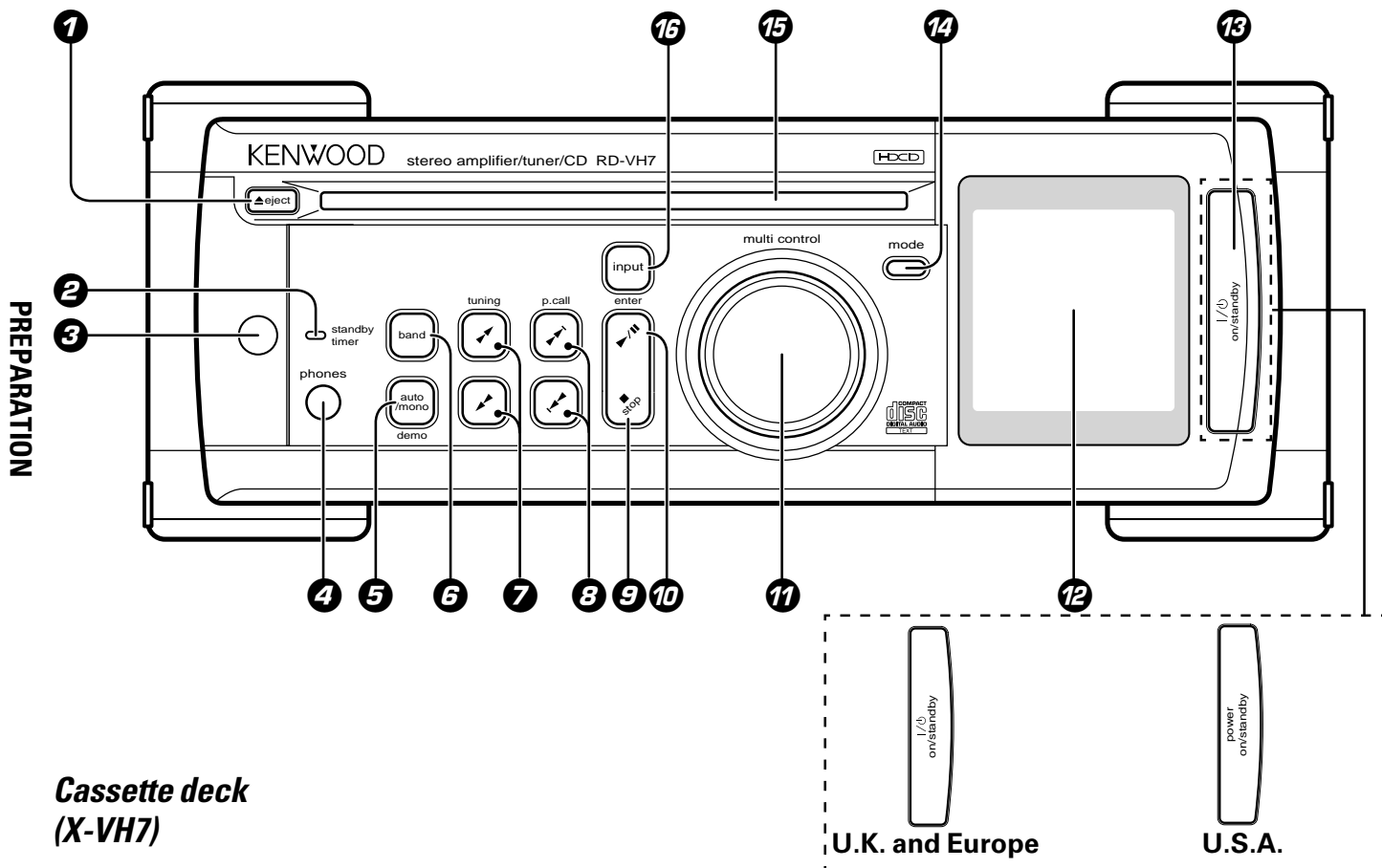

Cassette deck (X-VH7)

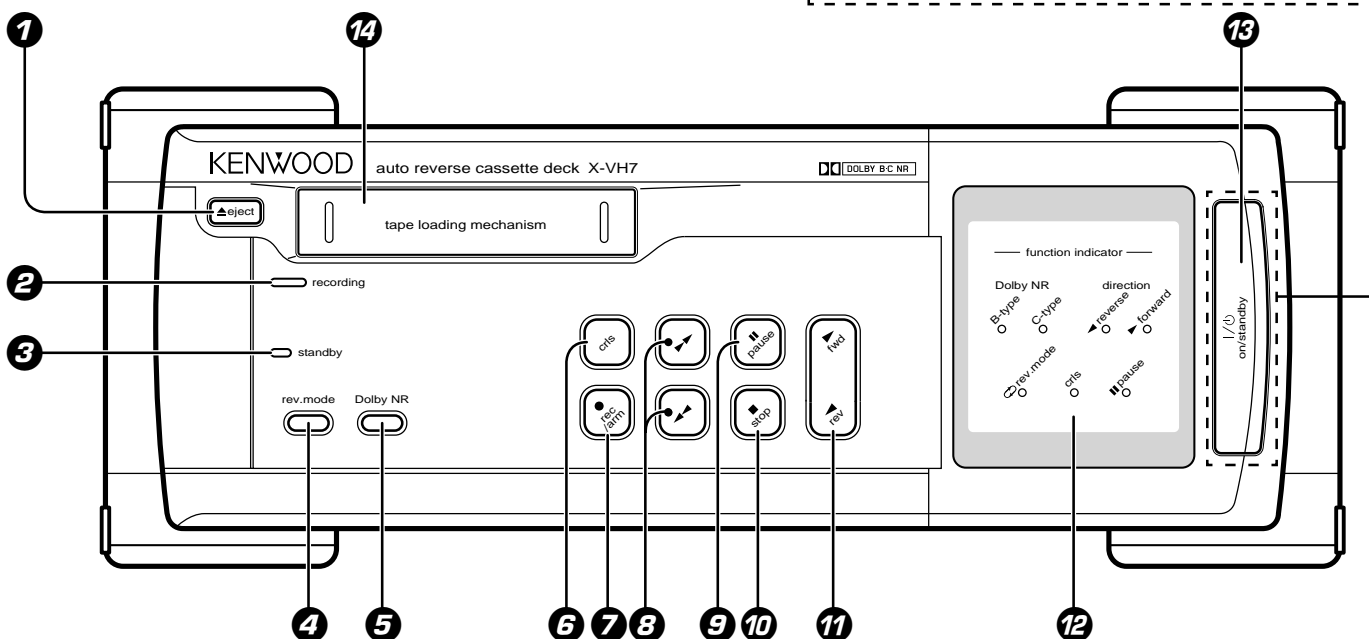

Standby mode

While the standby indicator of the unit is lit, a small amount of current is flowing into the unit's internal circuitry to back up the memory. This condition is referred to as the standby mode of the unit. While the unit is in the standby mode, it can be turned ON from the remote control unit.

Amplifier-tuner/CD player (RD-VH7)

- 1** "▲ eject" key → 40
The key lights in blue when a CD is loaded inside.
- 2** "standby/timer" indicator → 50, → 53
When power is ON :Not lit.
When power is OFF (standby) :Lights in red.
During timer standby :Lights in green.
- 3** Remote sensor
- 4** "phones" jack → 23
Plug headphones with a stereo mini-plug (optional).
- 5** "auto/mono, demo" key
Press to switch the demonstration mode ON and OFF. → 4
Press to switch the tuning mode when receiving radio. → 35
- 6** "band" key
When power is OFF (standby):
Press to turn the system power ON and start radio reception on the tuner. → 22
When power is ON:
Press to select the tuner input. → 34, → 35
During tuner reception:
Press to switch the radio band. → 34, → 35
- 7** "tuning ◀◀, ▶▶" keys
During CD playback:
Press to fast forward or fast reverse the track being played. → 27
During tuner reception:
Press to select a radio station. → 35
- 8** "p.call ◀◀, ▶▶" keys
During CD playback:
Press to skip CD tracks. → 27
During tuner reception:
Press to select a preset radio station. → 34

Cassette deck (X-VH7)

- 1** "▲ eject" key → 40
The key lights in blue when a cassette tape is loaded inside.
- 2** "recording" indicator → 45
- 3** "standby" indicator
When power is ON :Not lit.
When power is OFF (standby) :Lights in red.
- 4** "rev. mode" key → 41, → 45
Press to switch the reverse mode (two-way, one-way) of the cassette deck.
- 5** "Dolby NR" key → 41, → 45
Press to switch the Dolby Noise Reduction on/off and its type.
- 6** "crls" key → 46
Press to set the recording level automatically according to the recording source.
- 7** "● rec/arm" key → 45
Press to start recording. Pressing during recording stops it after leaving a non-recorded space (blank) of about 4 seconds.

- 9** "■ stop" key
When power is OFF (standby):
Press to display the time of the day for 5 seconds. → 21
During CD playback:
Press to stop playback. → 27
- 10** "enter, ▶/||" key
During operation mode setting:
Press to set an entry.
When power is OFF (standby):
Press to turn the system power ON and start CD playback. → 22
When CD input is selected:
Press to start playback or let it pause. → 27
- 11** "multi control" knob → 21, → 22, → 25, → 50
This knob is usually used to adjust the listening volume but can also be used in setting selection, timer reservation and clock adjustment operations.
- 12** Character data display
- 13** "I/⏻ on/standby, (power on/standby)" key → 22, → 50, → 53
Press to switch the power ON and OFF (standby).
When system components are connected through system control cords, press to turn the entire system power ON and OFF. → 21, → 24, → 25
- 14** "mode" key → 21, → 24, → 25
Press to initial a setting/selection mode.
- 15** CD insertion slot
- 16** "input" key → 22, → 44
Press to select an input source.
When TAPE, CD or MD is selected, the corresponding component starts to play automatically provided that a tape or disc has already been loaded in it.

- 8** "◀◀, ▶▶" keys → 41 ~→ 43
Press to fast forward or rewind tape.
- 9** "|| pause" key → 41, → 45
Press to let playback or recording pause temporarily.
- 10** "■ stop" key → 41, → 45, → 47 ~→ 49
Press to stop an operation.
- 11** "◀ rev, ▶ fwd" keys → 40 ~→ 44
Press to play a cassette tape.
When power is OFF (standby):
Press to turn the system power ON and start cassette tape playback.
- 12** "function indicator" → 40 ~→ 46
Press to display the playback/ recording conditions including the Dolby NR mode, tape direction, reverse mode, etc.
- 13** "I/⏻ on/standby, (power on/standby)" key
Press to switch the power ON and OFF (standby).
When system components are connected through system control cords, press to turn the entire system power ON and OFF.
- 14** Cassette insertion slot

Remote control Unit

When the system control cord is connected, this remote control can be used to operate the entire system. The keys on the remote control unit with the same names as on the main unit have the same function as the keys on the main unit.

PREPARATION

1 Timer-related keys



2 Numeric/ O.T.E. keys

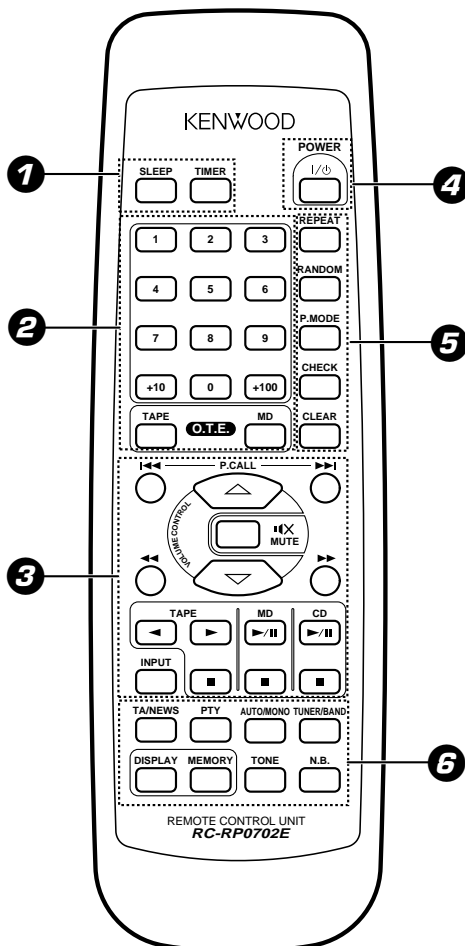
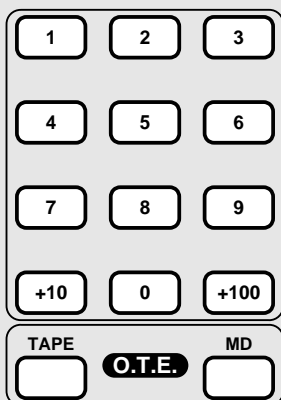

4 POWER key

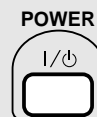

5 CD play mode/ program-related keys

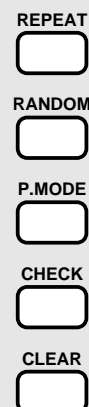

3 Basic operation/ input selection-related keys

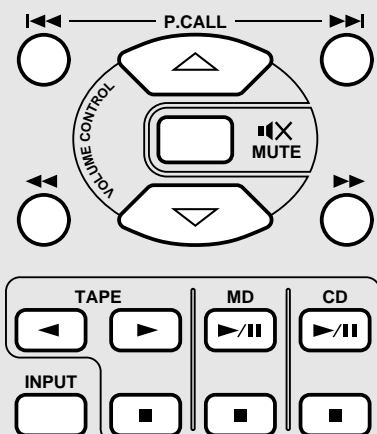

6 Tuner/ RDS operation, tone adjustment and display switching-related keys

RC-RP0702E only

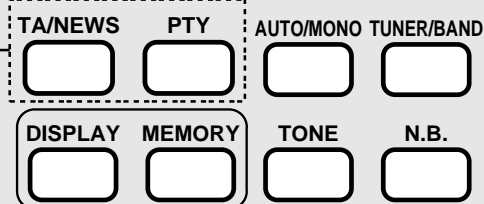

Model:
 For U.K. and Europe RC-RP0702E
 For U.S.A. and U.S. military RC-RP0702

1 Timer-related keys**"SLEEP" key** → 54

Press to set the sleep timer.

"TIMER" key → 50, → 54

Press to execute or cancel a timer program.

2 Numeric/ O.T.E. key**Numeric keys**

When CD or MD input is selected:

Press to enter numbers. → 27

During tuner reception:

Press when recalling a preset radio station. → 34, → 37

"O.T.E." (One-Touch Edit) key

This key is also used when programming tracks in a desired sequence and recording them. → 47

Press during CD playback to record the currently playing track onto a cassette tape or MD. → 48

Press during stop to record a CD from track number 1. → 49

3 Basic operation/ input selection-related keys**"|◀, ▶|" keys**

When the CD or MD input is selected:

Press to skip tracks. → 27

During tuner reception:

Press to select a radio station. → 34, → 37, → 39

"◀, ▶" keys

During CD or MD playback:

Press to fast forward or fast reverse the disc. → 27

During tuner reception:

Press to select radio stations. → 35

When the TAPE input is selected:

Press to fast forward or rewind the cassette tape. → 41

"VOLUME CONTROL" key → 22, → 23

Press to adjust the listening volume or tone.

MD control keys (▶/II, ■)

Press to control the MD recorder (DM-VH7).

CD control keys (▶/II, ■)

→ 27, → 30, → 32, → 33

Press to control the CD player.

Cassette deck control keys (◀, ▶, ■)

These keys are used to control the cassette deck (X-VH7). → 40, → 41, → 44, → 45

"MUTE" key → 23

Press to mute sound temporarily.

"INPUT" key → 22, → 44

Press to select an input source.

When TAPE, CD or MD is selected, the corresponding component starts to play automatically provided that a tape or disc has already been loaded in it.

4 POWER key**"|/⏻ POWER" key** → 22, → 50, → 53

Press to switch the power of the amplifier-tuner/CD player (RD-VH7) ON and OFF (standby). When system components are connected through system control cords, press to turn the entire system power ON and OFF. This key is also used in timer programming.

5 CD play mode/ program-related keys**"REPEAT" key** → 32

Press for repeat playback of a CD.

"RANDOM" key → 33

Press to play the tracks in a CD in a random order.

"P.MODE" key → 30, → 31

Press when programming CD tracks for program playback or program recording.

"CHECK" key → 31

Press to check the tracks programmed for CD program playback.

"CLEAR" key → 31, → 47

Press to clear the last track from the programmed CD tracks.

6 Tuner/ RDS operation, tone adjustment and display switching-related keys**"TA/NEWS", "PTY" key (RC-RP0702E only)**

→ 37, → 38

Press to switch the modes during RDS broadcast reception.

"AUTO/MONO" key → 35

Press to switch the tuning mode of the tuner.

"TUNER/BAND" key → 34, → 35

Press to select the tuner input.

This key is also used to switch the broadcast bands.

"DISPLAY" key → 28, → 36

Press to switch the displayed information on the amplifier-tuner/CD player (RD-VH7).

"MEMORY" key → 35

Press when presetting radio stations.

"TONE" key → 23

Press to adjust the highest and lowest frequencies.

"N.B." (Natural Bass) key → 23

Press to compensate for the tone.

Operation

Plug the power cord into a power outlet and press the " I/O POWER" key on the remote control unit to switch the power ON. Then press the key of the function you want to control.

- When pressing more than one remote control keys successively, press the keys securely by leaving an interval of 1 second or more between keys.

Operating range (approx.)

Remote sensor

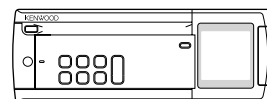

This unit incorporates a clock function. Be sure to adjust the correct time before using the timer function.

1 *Activate the clock adjustment mode.*

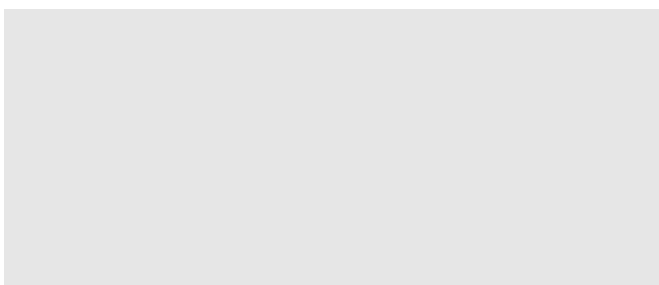

2 *Enter the hour.*

1 Adjust the figure of hour by rotating the "multi control" knob.

2 Press the "enter" key.

3 *Enter the minute.*

1 Adjust the figure of minute by rotating the "multi control" knob.

2 Press the "enter" key.

Example for adjusting
at 12:30PM

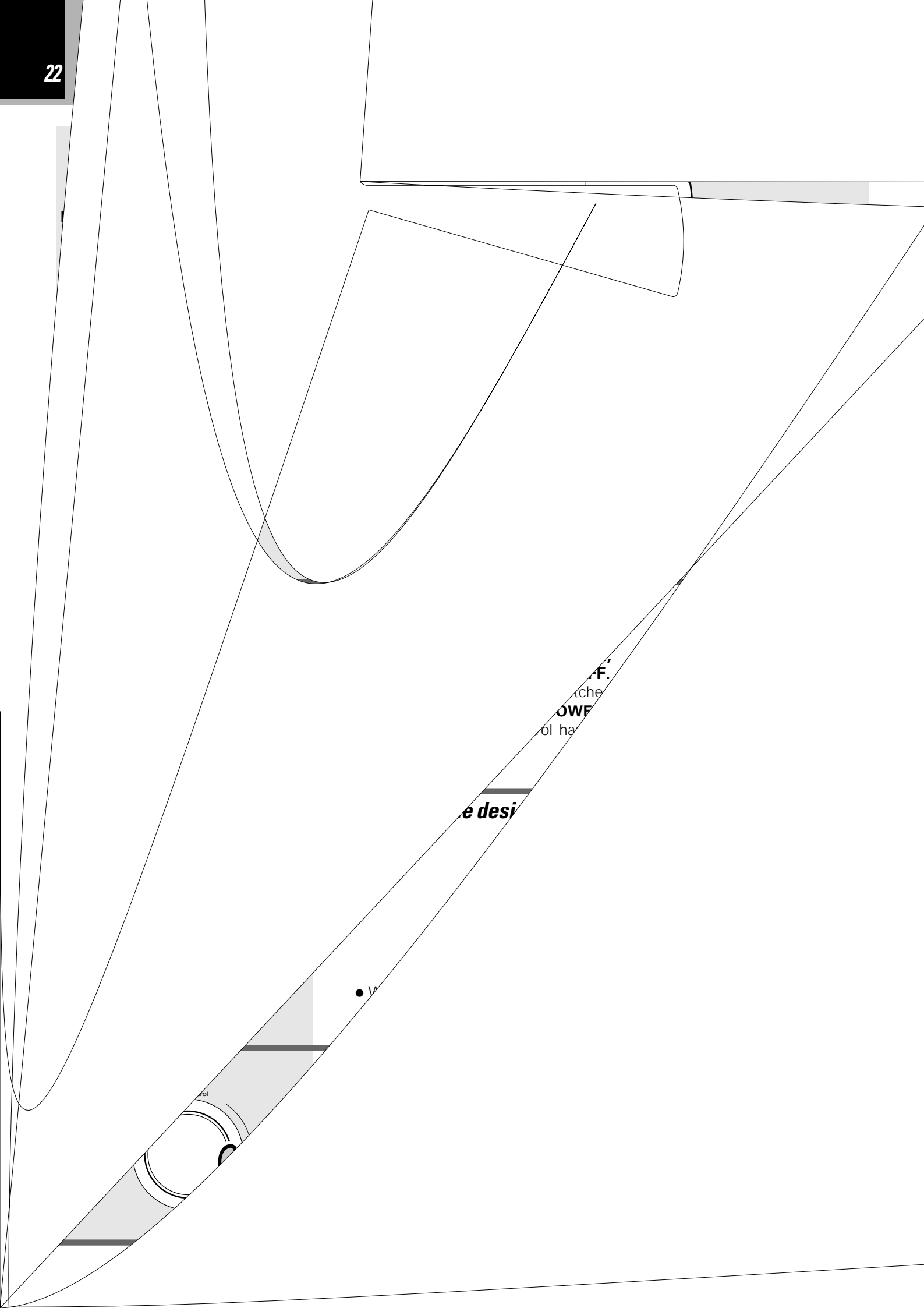

F.
tche
OWE
ol ha

e desi

rol



Muting the sound temporarily

Remote control unit only



Blinks



- Press again to resume the original volume.
- This is also cancelled when the volume is adjusted.

Listening through headphones

- 1 Insert the headphone plug into the phones jack.

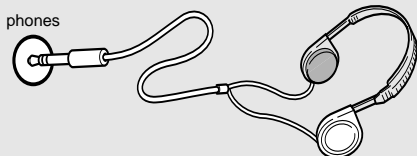

- Headphones with a stereo mini plug can be connected.
- The sounds from all speakers are cut off.

- 2 Adjust the volume with the "multi control" knob.

Tone adjustment (Remote control unit only)

The responses of the lowest frequencies (BASS) and highest frequencies (TREBLE) can be adjusted as desired.

After this adjustment, the N.B. effect will be disabled.

- 1 Press the "TONE" key to select "BASS". Adjust the level of lowest frequencies as desired using the "VOLUME CONTROL" keys.



TONE

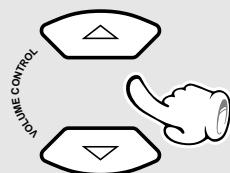

- 2 Press the "TONE" key again to select "TREBLE". Adjust the level of the highest frequencies using the "VOLUME CONTROL" keys.

- 3 Press the "TONE" key once more.



Lights when the tone has been adjusted

- The BASS and TREBLE can be adjusted independently in the range from -8 to +8.

Bass and treble compensation

(N.B.: Natural Bass circuit)

Remote control unit only



Lights

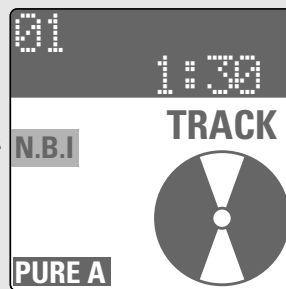

Each press switch the modes as follows.

"N.B.1" The high and the low range are compensated according to the volume (effective for low volumes).

"N.B.2" The high and the low range are compensated independent of the volume.

"TONE" or no indication

..... "TONE" appears only during the bass or treble tone adjustment. No indicator appears when the tone is not adjusted.

Balance adjustment

The balance of volumes from the left and right speakers can be adjusted as follows.

- 1 Press the "mode" key.
- 2 Rotate the "multi control" knob to select "BALANCE SET ?", then press the "enter" key.



Blinks

- 3 Adjust the left and right speaker balance by rotating the "multi control" knob.



- 4 Press the "enter" key.

Input level adjustment

The input levels of MD, TAPE and AUX can be adjusted independently. This is intended to minimize the difference between input levels from different input sources when these are switched over between them.

Possible when the MD (TAPE or AUX) input is selected

- ① Select the input source to be adjusted by pressing the "input" key.
- ② Press the "mode" key.
- ③ Rotate the "multi control" knob to select "MD LEVEL SET ?" ("TAPE LEVEL SET ?" or "AUX LEVEL SET ?"), then press the "enter" key.

MD LEVEL SET ?

Blinks

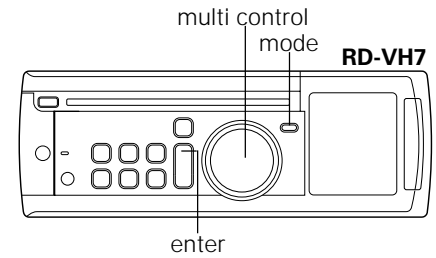
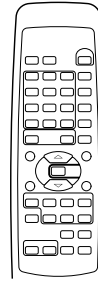

- ④ Adjust the input level by rotating the "multi control" knob.

MD INPUT +3

- The input level can be adjusted in the range from -6 to +3.

- ⑤ Press the "enter" key.

- Once the input level of a source component is altered, the recording level from the component will also be altered.

Listening in Pure A mode

The Pure A mode is switched on/ off automatically according to the current listening volume.

The Pure A mode allows you enjoy smooth and high sound quality even when listening to the audio at a close distance to the speakers or during low-level listening in the night time, etc.

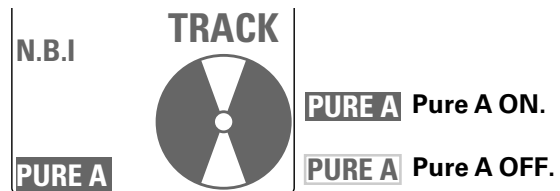

CAUTION

When pure A mode is selected, a certain amount of power is used even when no music source is played back, and the temperature of the amplifier section will rise.

What is Pure A?

The amplifier section amplifies the voltage and current of the input signal from the CD etc. and sends the output to the speakers. In order to suppress the distortion occurring with this amplification, amplifiers with class A operation or class AB operation always have current flowing through the circuits for current amplification. This is called the idling circuit. Especially an amplifier with class A operation has a high idling current in comparison to an amplifier with class AB operation, which is used by many units. As the result, class A operation has distortion suppressed to a minimum, and smooth playback with high quality is possible. However, as a certain amount of power is consumed even when no music source is played, the temperature of the amplifier section will become comparatively high. Thus a high-class amplifier with a large-capacity power supply is required to enjoy the sound quality of class A operation. The amplifier of this system usually functions as a class AB amplifier in normal mode. However, to allow the user enjoy the high sound quality of class A amplifier, it has been designed to be switched automatically between class A operation usable in low-level listening (Pure A) and class AB operation.

LCD contrast adjustment

The contrast of the LCD display on the amplifier-tuner/ CD player can be switched as desired.

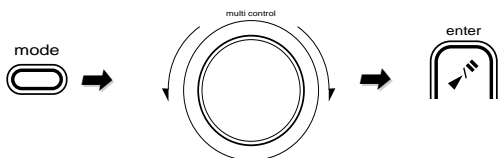

When the LCD display is invisible (due to too bright contrast), press and hold the "mode" key for more than 2 seconds. This resets the contrast to the initial value.

- ① Press the "mode" key.
- ② Rotate the "multi control" knob to select "CONTRAST SET ?", then press the "enter" key.



- ③ Select the desired brightness (display density) by rotating the "multi control" knob, then press the "enter" key.

- Adjust the contrast when the LCD display is hard to read due to a problem in the installation position or to the ambient temperature condition, etc.

LCD display orientation adjustment

The orientation of the LCD window on the amplifier-tuner/ CD player can be set to automatic switching according to whether it is installed vertically or horizontally (AUTO) or to manual switching as required by the user (MANUAL).

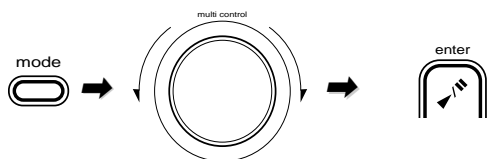

To cancel:

Select the desired switching method using steps ① to ③.

- ① Press the "mode" key.
- ② Rotate the "multi control" knob to select "WINDOW SET ?", then press the "enter" key.



- ③ Select "AUTO" or "MANUAL" by rotating the "multi control" knob, then press the "enter" key.

- When "MANUAL" is selected, the display orientation can be changed by rotating the "multi control" knob while "CHANGE ?" is displayed to select the desired display orientation and pressing the "enter" key.

Auto Power Save (A.P.S.)

When the power has been left ON for more than 30 minutes while the unit has been doing neither recording or playback in this period, the A.P.S. function switches the power OFF (standby) automatically. Whether the A.P.S. function is to be used or not can be set with the following steps.

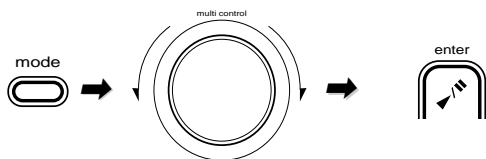

- ① Press the "mode" key.

- ② Rotate the "multi control" key to select "A.P.S. SET ?", then press the "enter" key.



- ③ Select "ON" or "OFF" by rotating the "multi control" knob, then press the "enter" key.



- With the **TUNER** and **AUX** input, A.P.S. functions only when the volume is set to zero.
- The LCD shows "A.P.S." while this function is active.

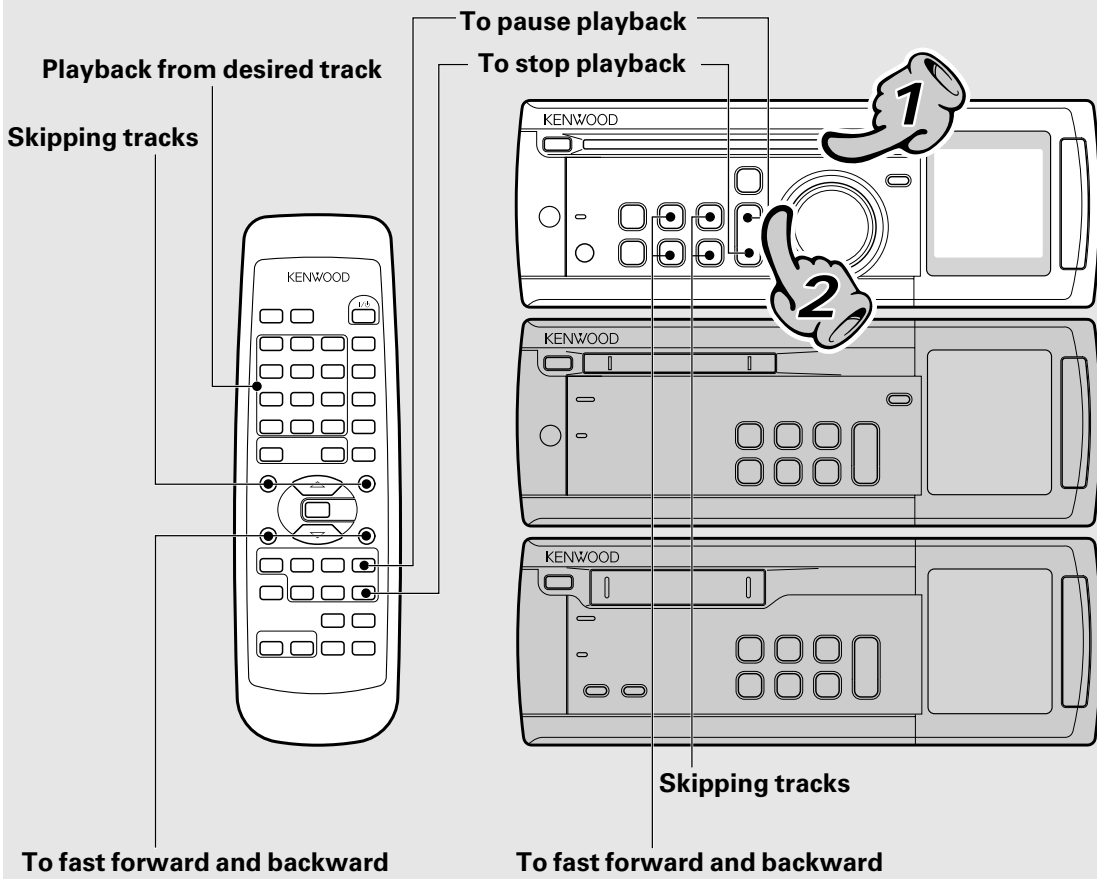

The label must be on top.

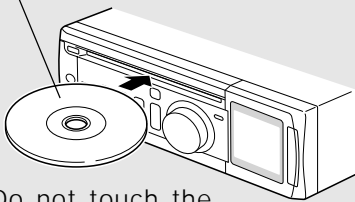

Do not touch the played surface.

Insert a disc in the insertion slot; it will be pulled in automatically into the deep of the unit.

1. Load/eject a disc.

Press the "▲ eject" key to eject the disc.

When taking the disc out of the unit, be sure to pull the disc straight out.

If the CD is pulled out in an oblique direction, the played surface may be damaged.

- No adapter is necessary to play an 8 cm CD.
- Discs with certain special designs (transparent discs, etc.) may not be able to be ejected by the first press. In such a case, try holding the "▲ eject" key depressed. If a disc cannot be inserted smoothly, try pushing it with a light force; this may promote the automatic insertion of the disc.

If the disc is stopped in the middle of loading or ejection, message "PLEASE PUSH EJECT KEY or PLAY KEY" is displayed and the "▲ eject" key blinks. In this case, press the "▲ eject" key to eject the disc.

- When the "▲ eject" key is pressed, the disc is pulled inside the unit then ejected. When the "▶/||" key is pressed, the disc is pulled in and starts to be played.

CAUTION

Do not attempt to insert a disc with peculiar shape (star shaped, heart shaped, etc.), crack or important warp or a stabilizer marketed for disc protection. Otherwise malfunction may result.

To pause playback

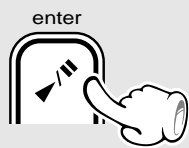

- Each press pauses and plays the CD alternately.

To stop playback

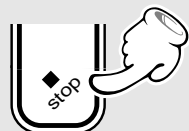

Playback from desired track

Remote control unit only

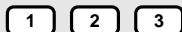

Select the desired track No.

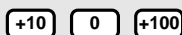
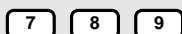
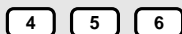

Press the numeric keys as shown below....

- To enter track No. 12 +10 2
- To select track No. 20 +10 +10 0

To fast forward and backward

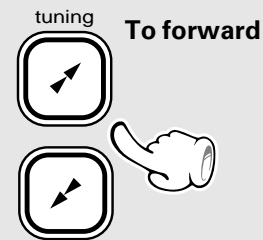

- Playback starts from the position where the key is released.

Skipping tracks



- The track in the direction of the button pressed is skipped, and the selected track will be played from the beginning.
- When the "I◀◀" key is pressed once during playback, the track being played will be played from the beginning.
- To skip further to the previous track, press the "I◀◀" key quickly.

2. Start playback.

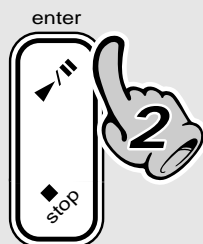

Appears during playback of a HDCD format disc.

Track No. being played (Upper line)
Elapsed track playing time (Lower line)

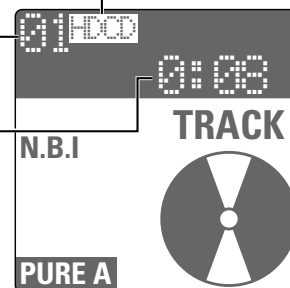

- After a few seconds, play starts from track No.1.

This CD player is capable of playing HDCD discs. The display shows "HDCD" during playback of a HDCD disc.

- The musical data recorded in the HDCD format features high 20-bit resolution, making it possible to reproduce music more delicately than ordinary CD discs.

Time display on CD player (Remote control unit only)

Each press of the "DISPLAY" key switches the displayed information items one after another.

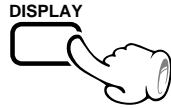

- Only the time information on the track being played can be displayed during single-track repeat playback or random playback.
- When the total playing time of the tracks programmed for program playback reaches 100 minutes or more, the display shows "----:--T" and the time display becomes unavailable.

CD TEXT data display (Compatible disc only)	
Elapsed time of track being played	
Remaining time of track being played	
Elapsed time of entire disc	
Remaining time on entire disc	

CD TEXT function

When a disc containing CD TEXT data (data including the disc title, track titles and performer names) is loaded, the LCD shows the text data recorded in the disc.

The text data can be displayed on up to 1000 characters. If a disc contains more data than this, the LCD shows "TEXT MEMORY FULL".

About HDCD mode (HDCD 20-bit digital output)

This mode is a special function, which outputs a digital signal by converting the music signal on the HDCD disk to 20 bit. This is most effective when recording from the HDCD disk to a digital device such as an MD.

- Set the digital out setting to "non-HDCD" when connecting to other devices that have the HDCD conversion function.
- Recording or playback of the correct music signal may not be possible when you choose HDCD and playback or record using another device.

Recording a HDCD disc

Use the following procedure to record digitally the digital input from a CD recorded in the HDCD format.

To make this possible, it is required to select whether the data from the HDCD disc is to be output as a HDCD-decoded 20-bit signal or as an ordinary 16-bit signal. (HDCD 20-bit digital output → )

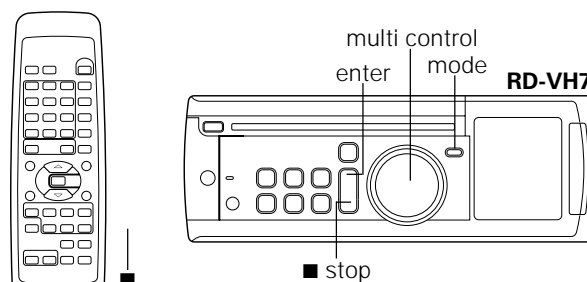

Select the "CD" input.

1 Check that the CD player is in the stop mode.

Press the "■ stop" key.



2 Select the HDCD mode.

1 Press the "mode" key.

2 Rotate the "multi control" knob to select "HDCD D-OUT SET ?", then press the "enter" key.

3 Rotate the "multi control" knob to select "non-HDCD" or "HDCD", then press the "enter" key.

- └ non-HDCD (initial setting)
- └ HDCD

3 Start recording.

(Refer to the instruction manual of the recorder component connected to this unit.)

Some HDCD discs may contain tracks which are recorded in the HDCD format and those which are not recorded in the HDCD format. (When such a CD is played, "HDCD" is not displayed during

- This mode selection is applied only to the digital output. During playback, discs are played automatically in the CD or HDCD mode.
- The speaker volume level is common for the CD and HDCD.

2 Mode selection

HDCD D-OUT
SET ? Blinks

3 HDCD selection

HDCD D-OUT
HDCD ? Blinks

When the "non-HDCD" mode is selected:

Data in a HDCD disc is output in the same format as an ordinary CD (16-bit signal).

When signals from HDCD format discs and ordinary CD discs are recorded onto a single MD, the two types of signals are recorded at the same recording level. However, note that recording in the HDCD format (20-bit) is not possible.

When the "HDCD" mode is selected:

This mode is to be selected to record a HDCD format CD disc onto an MD without processing the signal. This enables recording with a wider dynamic range and finer tone.

However, the HDCD format signals are recorded at a lower level than the ordinary CD signals.

Listening in the desired sequence (program playback)

Desired tracks in a disc can be programmed in the desired order and played back. (Max. 32 tracks)

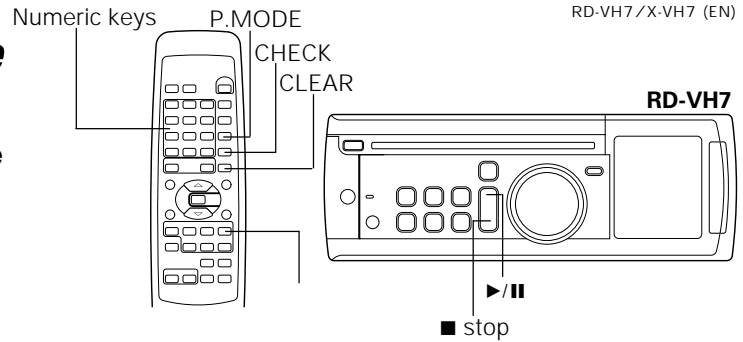

Select the "CD" input.

1 Check that the CD player is in the stop mode.

If it is in play mode
Press the "■ stop" key.

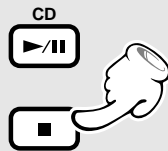

2 Light the "PGM" indicator.

Press the "P. MODE" key.

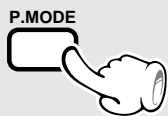

3 Enter track Nos. in the order you want to play them.

1 Select a track number using numeric keys.

Go to step 2
within 8 sec.

2 Press the "P. MODE" key.

3 Repeat steps 1 and 2.

4 Start playback.

Press the "CD ▶/||" key.

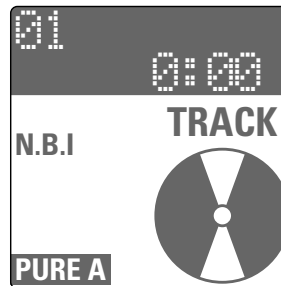

1 Track selection
Blinks

2 Programming

- Up to 32 tracks can be programmed. When "PGM FULL" is displayed, no more tracks can be programmed.
- After programming tracks, pressing the "CHECK" key allows to check the programmed tracks one by one.
- If the disc is a CD TEXT disc, the recorded text data will be scrolled on the LCD.

- Tracks will be played in the order they were programmed (in order of P Nos.).
- When the "◀◀" or "▶▶" key is pressed during play, the program will jump to the preceding or the following track respectively.
- When the "◀◀" key is pressed once during playback, the play position returns to the beginning of the current track being played.

To add a track to the program (Remote control unit only)

① Select the track number to be added using the numeric keys.

Press during stop.

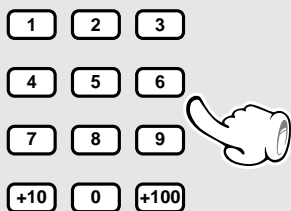

Press the numeric keys as shown below....

To enter track No. 12 **+10** **2**

To select track No. 20 **+10** **+10** **0**

② Press the "P. MODE" key.

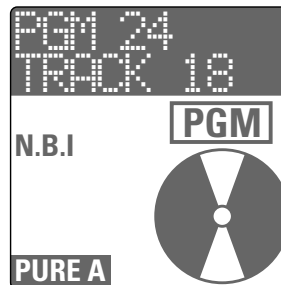
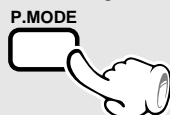

- Up to 32 tracks can be programmed. When "PGM FULL" is displayed, no more tracks can be programmed.
- When a track No. is entered, the track will be added to the end of the existing program.

To replace a programmed track (Remote control unit only)

① Press the "CHECK" key to display the track number to be replaced.

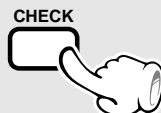

② Select the new, replacing track number using the numeric keys.

③ Press the "P. MODE" key.

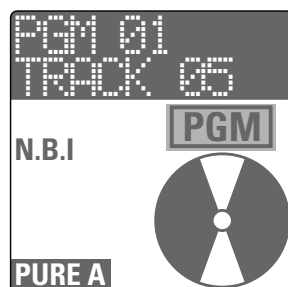

Blinks

- The track being played cannot be replaced.

To delete a programmed track (Remote control unit only)

Press the "CLEAR" key.



- Each press of the "CLEAR" key clears the last track in the program.
- A track being played can not be deleted.

To quit the program mode (Remote control unit only)

Press the "P. MODE" key.

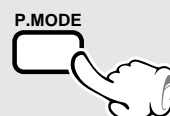

Lights

- If the key is pressed during playback, normal playback in order of tracks resumes from the current track.

Repeat playback

Desired disc can be played repeatedly.

ut.

Indicator is lit, press the key repeatedly until it turns off.

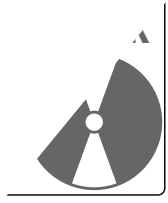

lit,

line s

P.CALL



keys as shown below

No. 12 +1

Track No. 20 +1

▶ playback repeatedly until

3 "REP."

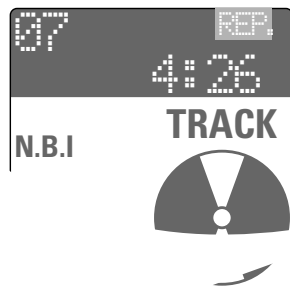

Lights

Repeat playback

- 1 Program procedure (press the "CD" key)
- 2 Press the "REP." key to select "REP."
- 3 Press the "CD" key to start playback.

To stop repeated playback

Press the "REPEAT" key repeatedly until the repeat-related indicator disappears.

- Normal playback will continue even if the "REPEAT" indicators have turned off.

Playing tracks in a random order (random playback)

Tracks in a CD can be played back in a random order so that the listener can enjoy unexpected playback of music.

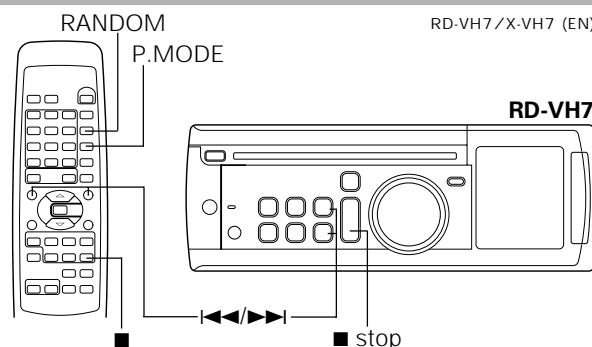

Select the "CD" input.

1 Confirm that the "PGM" indicator is not lit.

If the **PGM** indicator is lit, press the "P.MODE" key to turn it off.

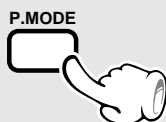

2 Start random playback.

Press the "RANDOM" key.

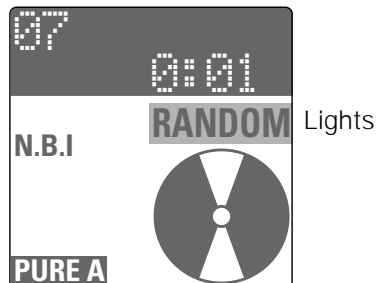

- Playback stops after each track has been played once.
- The random playback can also be repeated by pressing the "REPEAT" key.

To select another track in the middle of playing one

Press the "▶▶" key.

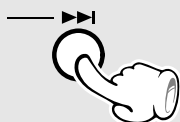

- Pressing the "◀◀" key once returns to the beginning of the track being played.

To cancel random playback

Press the "RANDOM" or "■ stop" key during random playback.

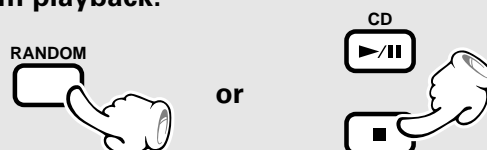

- Pressing the "RANDOM" key continues playback of tracks in the order they are recorded, while pressing the "■ stop" key stops playback.

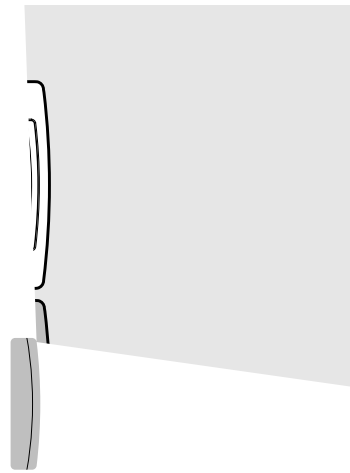

Manual tuning and preset operation

- ① Press the "band" key to select "FM" or "AM".



- ② Press the "auto/mono" key to select auto tuning or manual tuning.



- ③ Press the "tuning" key to receive a station.

Auto tuning mode : Each press receives a new station.

Manual tuning mode: Press repeatedly until the desired station is received.

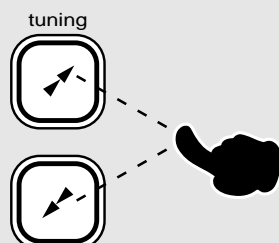

Collective presetting of stations (auto preset)

- ① Press the "band" key.

- ② Press the "mode" key.

- ③ Rotate the "multi control" knob to select "AUTO MEMORY ?" ("AUTO PRESET ?"), then press the "enter" key.



For U.K. and Europe

- For use of the RDS function, stations must be memorized by RDS auto presetting.
- RDS stations are given priority during auto presetting. If there is memory left after presetting, the receiver continues presetting regular FM stations.

One-by-one presetting (manual preset)

- ① Press the "MEMORY" key on the remote control unit during reception of a desired station.

- ② Select the desired preset number between 1 and 40 using the numeric keys on the remote control unit.



- ③ Press the "MEMORY" key.

- Repeat steps ①②③ to preset other stations.
- If several stations are preset under the same number, the previous memory is replaced with the latest memory contents.

For U.K. and Europe

- For memorizing of stations other than RDS stations (FM, AM), memorize the stations according to chapter "One-by-one presetting (manual preset)".

RDS is a system that transmits useful information (in the form of digital data) for FM broadcasts along with the broadcast signal. Tuners and receivers designed for RDS reception can extract the information from the broadcast signal for use with various functions, such as automatic display of the station name.

For reception of RDS stations, the RDS auto presetting function must be used to preset the stations. →  35

"NO DATA" will be flashed when a station not preset by auto presetting is received.

This unit is equipped with the following functions utilizing RDS data:

PS (Program Service Name) Display : (See below.)

When an RDS broadcast is received, the station name is automatically displayed.

RT (Radio Text) display: (See below.)

Displays the radio text data transmitted by some RDS stations when you press the "DISPLAY" key. There is no display if no text data was transmitted.

PTY (Program Type Identification) Search : → 37

The tuner automatically searches for a station which is currently broadcasting a specified program type (genre).

EON (Enhanced Other Network) : → 38

When the information to be received is set in advance and any RDS station in the same network starts broadcasting of such information, the reception automatically will be switched to that station.

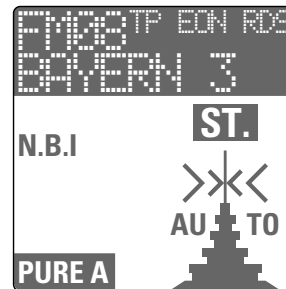

The "RDS" indicator lights up when an RDS broadcast (signal) is received.

* Some functions may not be provided or be given different names depending on countries or areas.

To switch the display contents

Press the "DISPLAY" key.

Pressing the "DISPLAY" key changes the display contents.

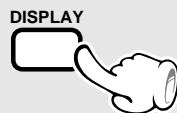

Display mode priority ranking

PS (Program Service Name) Display :



When an RDS broadcast is received, the station name is automatically displayed. If no PS data was sent, "NO PS" is displayed.

RT (Radio Text) display:



Text data accompanying the RDS broadcast scrolls across the display. "NO RT" is displayed if the current RDS station does not provide RT data.

Frequency Display :



The frequency of the current station is displayed.

Searching for a desired program type (PTY search)

By specifying the type of program (genre) you want to listen to, the tuner automatically searches for a station which is currently broadcasting a program of the specified type.

Under certain receiving conditions, it may take more than 1 minute to complete the search.

For reception of RDS stations, the RDS auto pre-setting function must be used to preset the stations. → 35

Set the reception band to FM.

1 Activate the PTY search mode.

Press the "PTY" key.



When an RDS broadcast is received, the program type is shown on the display. If no PTY data is available, or if the station is not an RDS station, "NONE" is displayed.

2 Select the program type you desire.

Use the program type table on the right for your convenience.

A To select using the "P.CALL" keys

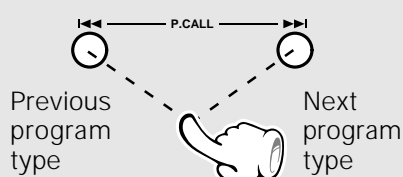

The "P.CALL" keys let you select from all 29 program types in the order shown at right. Press the key and release it when the desired type is displayed.

B To select with the numeric keys

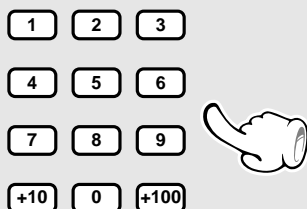

The numeric keys allow you to select programme types 1 to 0 directly. If you want to select one of the other programme types, use the "P.CALL" key.

Program type table

(A)	(B)	Program Type Name	Display
	1	Pop Music	POP M
	2	Rock Music	ROCK M
	3	Easy Listening Music	EASY M
	4	Light Classical	LIGHT M
	5	Serious Classical	CLASSICS
	6	Other Music	OTHER M
	7	News	NEWS
	8	Current Affairs	AFFAIRS
	9	Information	INFO
	0	Sport	SPORT
		Education	EDUCATE
		Drama	DRAMA
		Culture	CULTURE
		Science	SCIENCE
		Varied	VARIED
		Weather	WEATHER
		Finance	FINANCE
		Children's programs	CHILDREN
		Social Affairs	SOCIAL
		Religion	RELIGION
		Phone In	PHONE IN
		Travel	TRAVEL
		Leisure	LEISURE
		Jazz Music	JAZZ
		Country Music	COUNTRY
		National Music	NATION M
		Oldies Music	OLDIES
		Folk Music	FOLK M
		Documentary	DOCUMENT

TUNER OPERATION

"NO DATA" is displayed if this operation is attempted before performing the RDS auto presetting function.

3 Start the search.

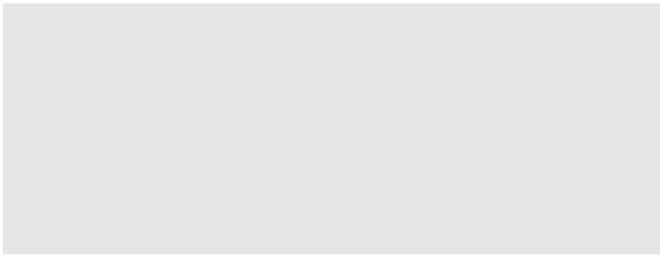

To select another program type

Repeat steps **1**, **2** and **3**.

- No sound is heard while **"ROCK M"** is blinking.
- If the desired program type cannot be found, **"NO PROG"** is displayed, then after several seconds the display returns to the original display.
- If the desired program type is found, that program is received. The program type display changes temporarily to the frequency display, and then to the station name display.

EXAMPLE: Searching for a Rock Music broadcast.

Blinks Program type name display

Station name display

1 Select the desired information.

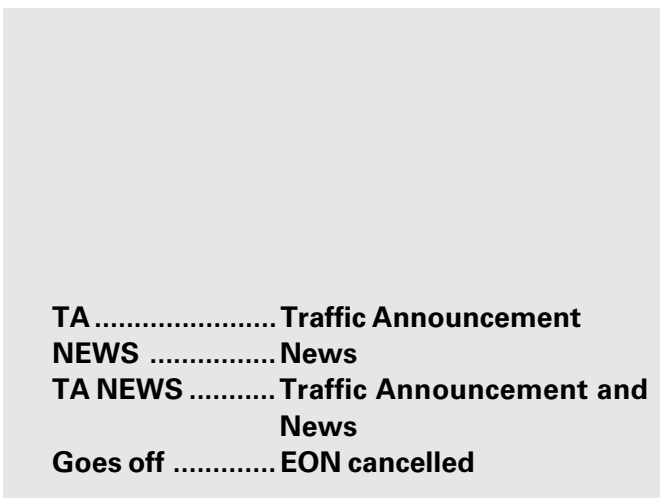

When **"TA"** is selected (ih Tm 0 Tc.027 Tc f77e)ic A -1.2(92en 3

- If **"TA"** and **"NEWS"** can not be selected, carry out the **"Collective presetting of stations (auto preset)"** again.

2 Receive an RDS station.

Press the "◀◀" or "▶▶" key.

Select a station where
"RDS" and "EON" are lit.

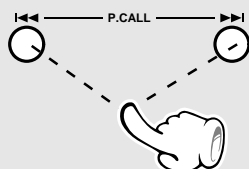

3 Wait for the desired information.

CD or tape playback also may be started.
As long as the power is ON, standby condition
will exist.

TP (Traffic Program) Indication

When the "TP" indication is lit, this indicates that this station or a station in the same network is transmitting traffic information.

When "TP" is displayed for the station presently being received, the traffic information of this station can be heard even without EON reservation.

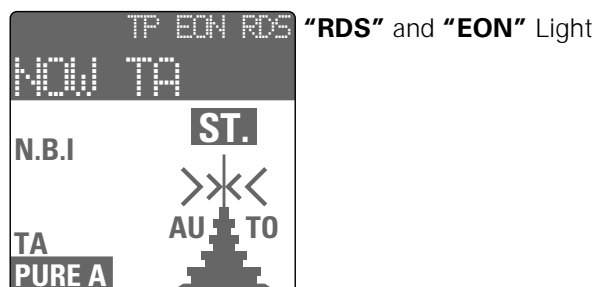

- When "TA" has been selected in step 1, always select a station for which the "NOW TA" is display.
- When "EON" does not light although an RDS station is received, that station is not transmitting EON data. Please select a different station.

When listening to the tuner:

Be sure to stay tuned to stations that display both the "EON" and "RDS" indicators.

To listen sources other than the tuner:

1. Tune in a station which that displays both the "EON" and "RDS" indicators, then use the "input" key to switch the input to the source you desire.
2. Even when the input is set to a source other than tuner, it will automatically switch to tuner when the desired EON program starts to broadcast. During this period, the source selected in step 1 continues playing, but will not be heard.
3. When reception of the desired EON program is complete, the input returns to the previous input source.
 - Do not use the EON function during recording.
 - When the transmission of the selected program contents ends in case of automatic reception with the EON function, return will be made to the status directly before operation of the EON function.

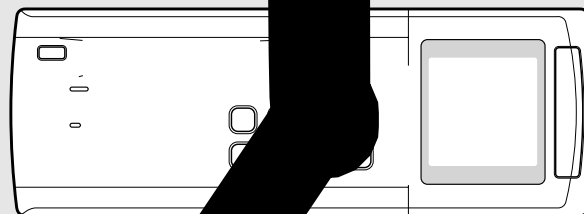
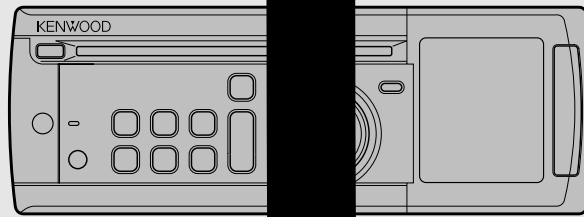

Selection of reverse mode

To stop playback

To reduce tape speed

To play tape at high speed

Tape exposed side

1. Load a cassette tape.

Press the "▲ eject" key to eject the cassette.

Avoid using tapes of which the label is not firmly adhered.

→ 56

Normal (TYPE I), high (TYPE II), or metal (TYPE IV) tape selection is set automatically.

- It is not recommended to use a 100-minute or longer cassette tapes, for these tapes are very thin and may easily cause troubles such as entanglement and cutting.
- Remove tape slack before loading.

→ 56

2. Start playback.

Press the "◀ rev" or "▶ fwd" key according to the desired tape transport direction.



To pause the tape



- Press the "◀ rev" or "▶ fwd" key to restart playback.

To wind tape at high speed



- Press the "■ stop" key

Selection of re

To stop playback

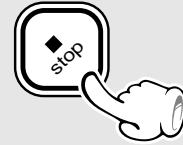

- The tape direction lights red.

To reduce tape noise (Dolby NR)

The Dolby Noise Reduction system reduces inherent noise to tape playback. This cassette deck incorporates the C Type Dolby NR in addition to the standard B Type.

Set the Dolby NR according to the Dolby NR used when recording each cassette tape.

Dolby NR
B-type
C-type

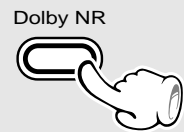

Switch the modes as follows.

- When B Type is played using B Type.
- When C Type is played using C Type.
- When NR is deactivated.

Transp



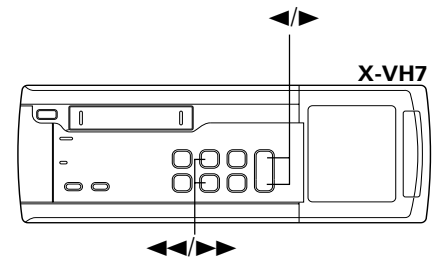

DPSS (Direct Program Search System)

DPSS (Direct Program Search System) permits easy location of the beginning of the desired tune or skipping of tunes on a cassette tape just like a CD by detecting non-recorded blanks of more than 4 seconds on tape as the "spaces between tunes".

Skip search

Plays the desired music program from the beginning by skipping programs until you reach the desired program. Up to 16 programs can be skipped.

Cassette deck only

During forward playback (while ► is blinking)

- To play the next program : Press once.
- To play the 4th program after the current program : Press 4 times.

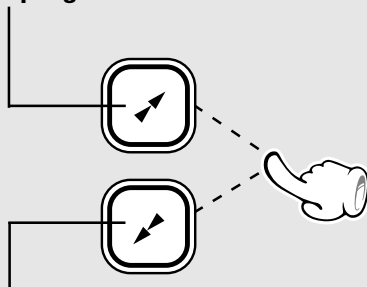

- To return to the beginning of the current program : Press once.
- To play the 4th program before the current program : Press 5 times.

During reverse playback (while ◀ is blinking)

- To return to the beginning of the current program : Press once.
- To play the 4th program before the current program : Press 5 times.

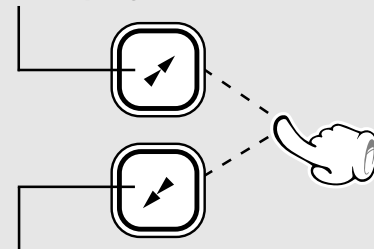

- To play the next program : Press once.
- To play the 4th program after the current program : Press 4 times.

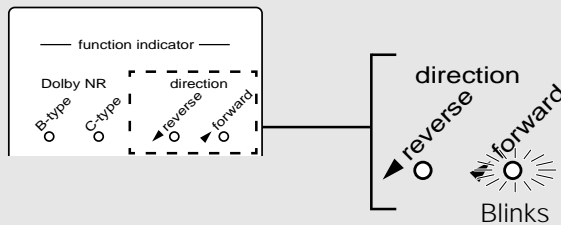

During fast forwarding (Quick blinking)
 During playback (Slow blinking)

Listening with fast forward for unrecorded portions (dash & play)

Plays music programs repeatedly by skipping non-recorded blank of more than 10 seconds.

Cassette deck only

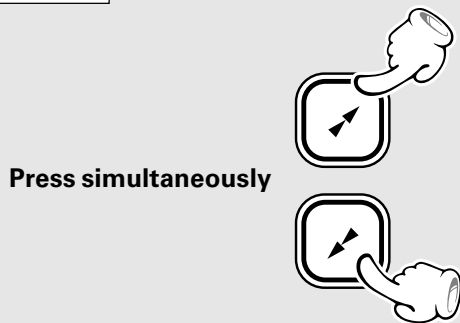

Press simultaneously

The operation changes in reverse mode.

- "↺" lit The two tape sides are played 8 times, after which playback stops.
- Goes off A tape side is played 8 times, after which playback stops.

- When the "■ stop" key is pressed, playback stops and the dash & play is cancelled.

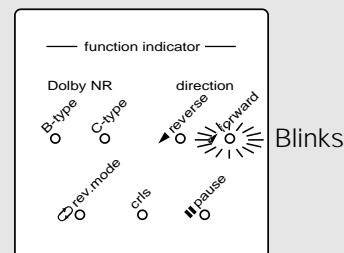

One-program repeat playback

Plays a single music program repeatedly up to 16 times.

Cassette deck only

Press the "▶ fwd " or "◀ rev " key during playback.

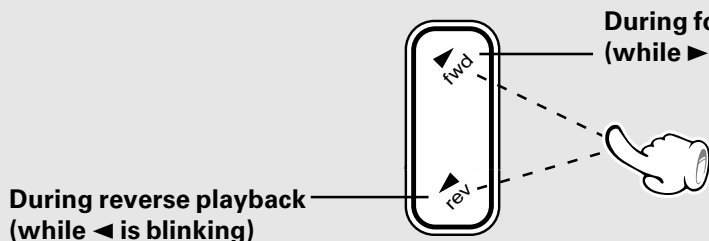

- The program being played will be repeated 16 times, after which normal playback resumes.
- When the "■ stop" key is pressed, playback stops and the one-program repeat is cancelled.

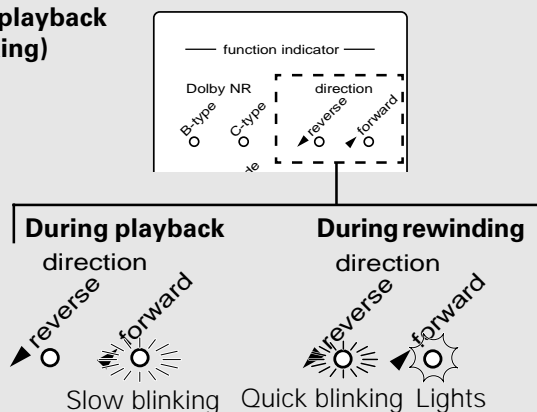

Rewind playback

Rewinds tape to the beginning and restarts playback from there.

Cassette deck only

Press the "▶ fwd " or "◀ rev " key simultaneously with the "◀◀" or "▶▶" key.

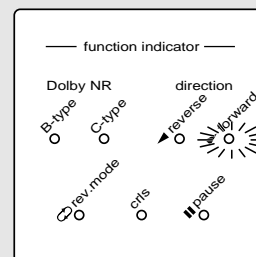
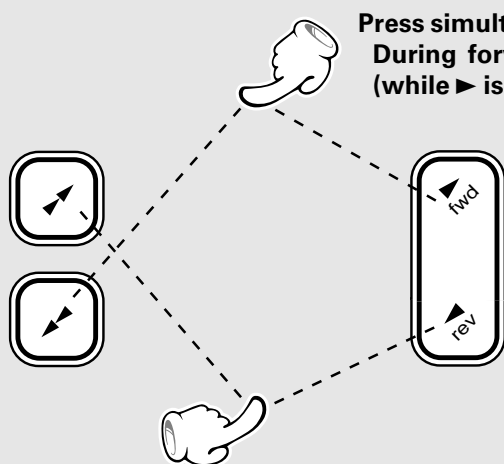

During playback
(Slow blinking)
During rewinding
(Quick blinking)



The DPSS may not function normally with the following kinds of tape.

- Tapes containing several no-sound intervals of more than 4 seconds, such as conversation and talk tapes.
- Tapes containing pianissimo sections, such as classical music tape.
- Tapes in which large noise is recorded in blanks between programs.
- Tapes containing blanks between programs that are shorter than 4 seconds.
- Tapes recorded at low level.
- Tapes recorded by cross-fade recording (in which the beginning of next program is overlapped on the end of previous program).



Note that this cassette deck cannot record onto Metal tapes.

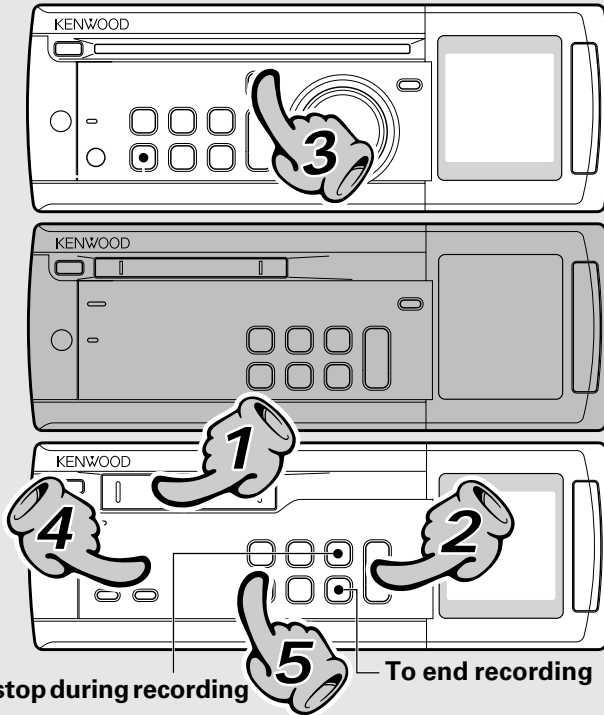
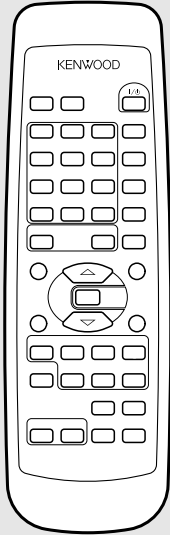

Temporary stop during recording — To end recording

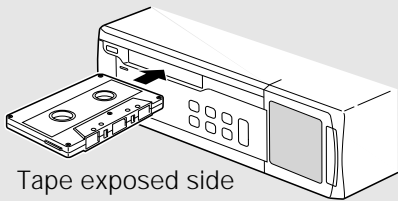

Tape exposed side

1. Load a tape in deck.

Insert the cassette straight into the insertion slot. Just push lightly and the cassette will be pulled automatically inside.

- Normal (TYPE I) or high (TYPE II) tape selection is set automatically.
- It is not recommended to use a 100-minute or longer cassette tapes, for these tapes are very thin and may easily cause troubles such as entanglement and cutting.
- Remove tape slack before loading.
- Avoid using tapes of which the label is not firmly adhered.

— 56
— 56

Cassette deck

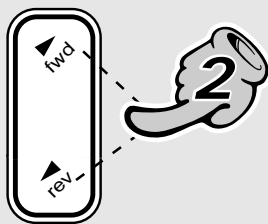

2. Select the tape transport direction.

1 Press the "▶ fwd" or "◀ rev" key for the direction to be played.

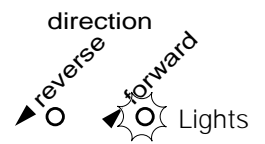

2 Press the "■ stop" key.

- Wind the tape to the position where recording is to be started.

3. Select the source to be recorded.

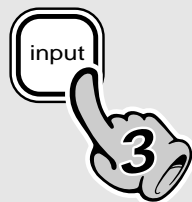

- ▶ TUNER (Radio broadcasting) — 34
- CD — 26
- MD
- TAPE (Recording is impossible.)
- AUX — 13

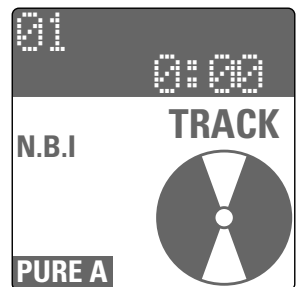

The selected recording source is displayed.

Select an input source other than "TAPE" input.

Temporary stop during recording

Cassette deck only

recording Lights pause Lights

● Press the "● rec/arm" to restart recording.

To end recording

Cassette deck

stop

An unrecorded portion of about 4 seconds is produced (auto recording mute)

To enter record-pause mode from stop mode after leaving a non-recorded blank of about 4 seconds

- 1 Press the "■ stop" key to set the cassette deck in stop mode.
- 2 Press the "● rec/arm" key twice.

Cassette deck only

recording Lights pause Lights Press twice. rec/arm

Blinks for 4 sec. then lights steadily.

To enter record-pause mode from record mode after leaving a non-recorded blank of about 4 seconds

Cassette deck only

Press the "● rec/arm" key during recording.

recording Lights pause Lights rec/arm

Blinks for 4 sec. then lights steadily.

Each press switch the modes as follows.

rev.mode Dolby NR

4

rev.mode Dolby NR

B-type C-type

Lights Lights

4. Set the recording condition.

- 1 Select the reverse mode.
 - ↳ "↔" lit Tape stops after having recorded the two sides.
 - ↳ Goes off Tape stops after having recorded one side of tape.
- 2 Select the Dolby NR mode.
 - ↳ "B-type" ... Tape is recorded using B Type.
 - ↳ "C-type" ... Tape is recorded using C Type.
 - ↳ Goes off Dolby NR is deactivated.

5. Start recording.

- 1 Press the "● rec/arm" key.

recording Lights

- 2 Play (or tune) the input source to be recorded.

- The recording level is adjusted automatically when the "cris" function is used.
- Recording stops automatically when the tape side(s) to be recorded have been fully recorded.

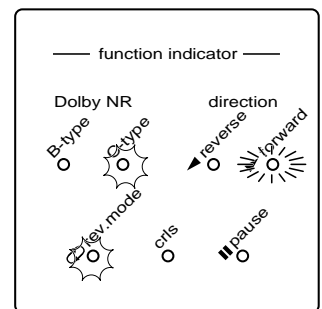

To restart recording

Press the "◀◀" or "▶▶" key in the middle of recording.

Cassette deck only



During reverse recording
(while ◀ is blinking)

During forward recording
(while ▶ is blinking)



Return to the recording start position and stop there.

Tape stops after 2 sec. of transport.

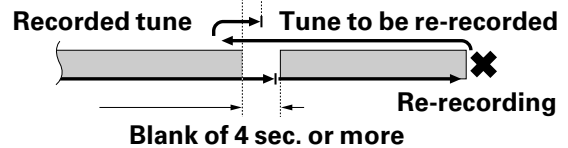

- Recording is stopped, tape is rewound and stopped after leaving a non-recorded blank of about 2 seconds (provided that there is already a blank of 4 seconds or more before the point where the first recording was started).
- If there is neither recording nor a 4-second non-recorded blank before the point where the first recording was started, the tape will be rewound till the beginning before being stopped.

Automatic Adjustment of the Recording Level (crls)

A standard recording level has been set in advance for the cassette deck (X-VH7), but when the crls function is used, the max. recording level is set automatically for the music source.

Cassette deck only

① Play the contents to be recorded (or receive the radio station to be recorded).

② Press the "crls" key.

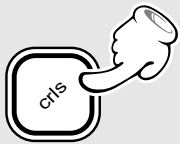

About 20 sec.

If you press the "crls" key...

The recording level is automatically adjusted and set as the recording level. In case you change the disk or change the source, set again.

If you do not press the "crls" key at all...

The input sound is recorded in the basic level that has been set previously.

- The recording level setting completes in about 20 seconds, after which the deck enters record-pause mode.
- If recording is started before the above setting completes (i.e. while the "crls" indicator is blinking), the recorded sound may be distorted.
- The recording level cannot be set if no source sound is input for 3 seconds or more after the "crls" key is pressed.

To return to the basic level:

Press and hold the "crls" key for about 3 seconds, until the "crls" indicator goes off.

Synchronized recording

When recording a CD or MD onto cassette tape, the tape recording can be started in synchronism with the start of CD or MD playback. This convenient function is available by setting both the cassette deck and CD player (or MD recorder) in pause mode and starting playback on the CD player (or MD recorder).

This operation is available only when the RD-VH7 and X-VH7 are interconnected with a system control cord.

- ① Press the "▶/II" key on the CD player or MD recorder twice.
- ② Use the skip keys (◀◀, ▶▶) to select the title to be recorded.
(Pause will be reached at the beginning of the selected title.)
- ③ Press the "● rec/arm" key on the cassette deck twice.
(The cassette deck enters record-pause mode.)
- ④ Press the "▶/II" key on the CD player or MD recorder.
(Synchro recording will start.)

- The recording is stopped when the stop key of the playback unit is pressed.

Recording CD tracks in the desired sequence (Program recording)

Desired tracks in a CD can be programmed in the desired order and recorded. (Max. 32 tracks)
The order of tracks in the program can be changed any time even after it has been set.

→ 31

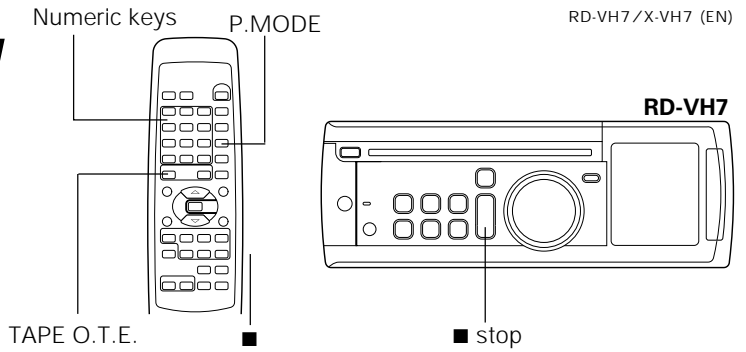

Select the "CD" input.

1 Check that the CD player is in the stop mode.

If it is in play mode

Press the "■ stop" key.

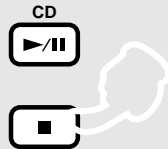

If you set "crs" beforehand you can enjoy better recording.

→ 46

2 Light the "PGM" indicator.

Press the "P.MODE" key.

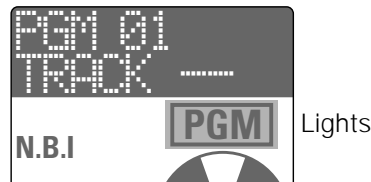
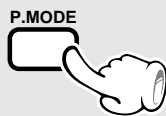

3 Enter track Nos. in the order you want to record them.

1 Select a track number using numeric keys.

Go to step 2 within 8 sec.



Press the numeric keys as shown below....

To enter track No. 12 +10 2

To select track No. 20 +10 +10 0

2 Press the "P.MODE" key.

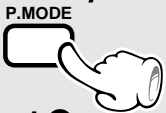

3 Repeat steps 1 and 2.

4 Start recording.

Press the "TAPE O.T.E." key.



- When the MD recorder is connected to the amplifier-tuner/ CD player, pressing the "MD O.T.E." key allows to record the CD track onto an MD.

1 Track selection

Blinks



2 Programming



- Up to 32 tracks can be programmed. When "PGM FULL" is displayed, no more tracks can be programmed.
- Each press of the "CLEAR" key clears the last track in the program.
- Program tracks so that their total playing time does not exceed the available recording time.

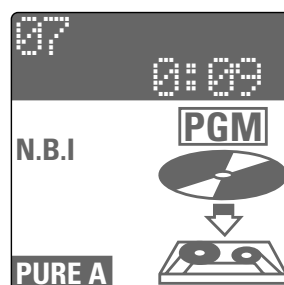

Recording only desired tracks (ONE TOUCH EDIT.....single track recording)

When playing a CD and a track that you want to record begins, simply press the "O.T.E. (One-Touch Edit)" key. This allows to record the current track from the beginning.

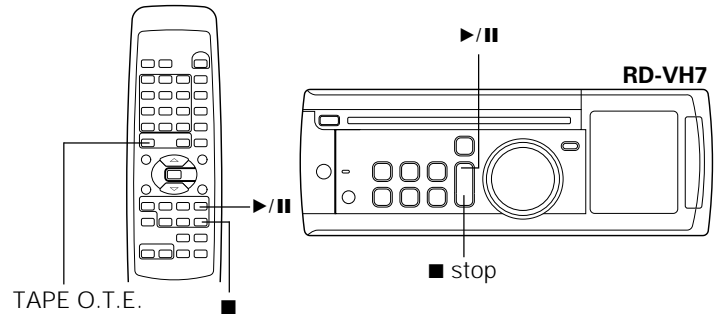

Recording preparations are required.

→ 44 , → 45 (Steps 1 to 4)

1 Play a CD.

Use other mode than random playback.

Press the "▶/|| CD" key.

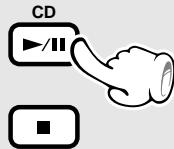

If you set "crfs" beforehand you can enjoy better recording.

→ 46

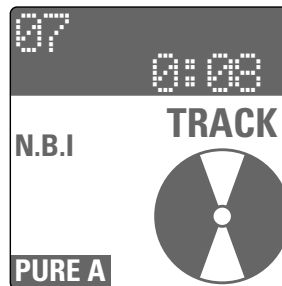

2 If you want to record the track being played.

Press the "TAPE O.T.E." key.

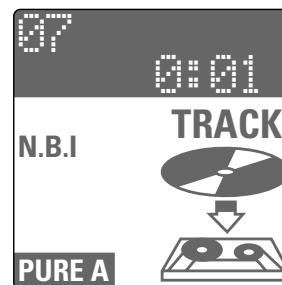

In case the key is pressed with track No.7.

- Playback restarts from the beginning of the track being played and recording starts at the same time.

- When the MD recorder is connected to the amplifier-tuner/ CD player, pressing the "MD O.T.E." key allows to record the CD track onto an MD.

When recording has been completed, a non-recorded portion of 4 seconds will be produced and the cassette deck part will stop. The CD player will enter temporary stop condition.

To record a different track, repeat the steps 1 and 2.

To end recording in the middle

Press the "■ stop" key in the middle of playback.

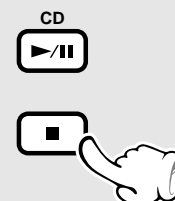

One-touch recording of an entire CD

(ONE TOUCH EDIT.....recording of all tracks)

The recording of a CD can be started at the same time as starting its playback with a single, one-touch operation, by simply pressing the O.T.E. (One-Touch Edit) key while the CD player is in stop mode.

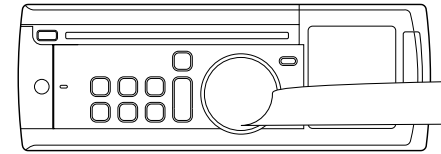

Recording preparations are required.

→ 44, → 45 (Steps 1 to 4)

1 Check that the CD player is in the stop mode.

Press the "■ stop" key.

2 Start recording.

Press the "TAPE O.T.E." key.



- Recording of CD starts at the same time as playback.
- When the tape direction is changed at the end of the tape, no sound is recorded on the guide tape. When interruption of a track is to be avoided, restart recording from the very beginning of the reverse side according to "Recording onto cassette tape". → 44

To end recording in the middle

Press the "■ stop" key in the middle of playback.

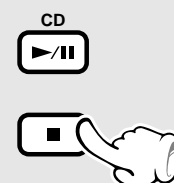

- Both the cassette deck and CD player stop.

The following three kinds of timer operations are available for use according to purposes.

- **O.T.T. timer**
- **Program timer playback (AI timer playback) and timer recording**
- **Sleep timer**

Be sure to adjust the clock before setting the timer.

→ 21

O.T.T. timer

By simply setting the ON time of O.T.T. timer playback automatically in one hour after the start of timer playback.

When the program timer is switched ON, it is switched OFF automatically after one hour. The program timer does not operate during playback by the O.T.T. timer.

- 1 Select the desired source and adjust its volume.
- 2 Press the "mode" key.
- 3 Rotate the "multi control" knob to select "TIMER SET ?", then press the "enter" key.
- 4 Press the "timer" key.

3 Setting selection



timer

timer

.../standby"
 (The "standby/t...
 green.)

... key
 tedly until
 T.T. timer
 back.

Program timer playback (AI timer playback) and timer recording

Two timer programs (PROG.1, PROG.2) are available. Both of them are 24-hour timer programs which can be executed every day.

Each of timer reservation programs PROG.1 and PROG.2 can store the time zone and contents of timer operation, which can be executed or deactivated as required.

1 Select the source to be played (recorded) and adjust its playback volume.

<input type="text"/>	● To listen to CD	● To listen to tape
The station should be preset prior. →  34	Insert a disc. (Program playback is not possible.) →  26	
<input type="text"/>	<input type="text"/>	

2 Select the timer reservation mode.

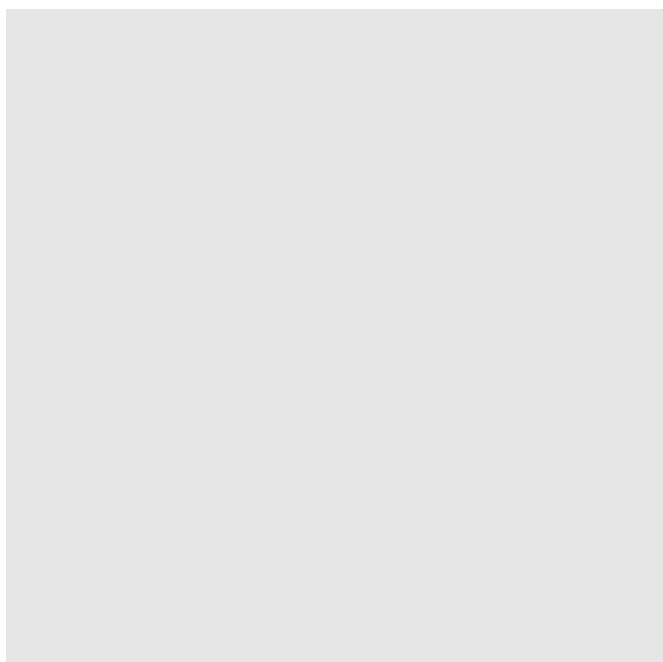

- If you make a mistake in the middle, press the “mode” key to cancel the operation and restart it from step 5 60.98 367

3 Enter the ON time.

- ① Set the timer ON time by rotating the "multi control" knob.

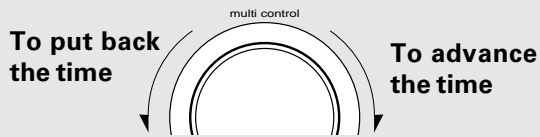

- ② Press the "enter" key.

- ③ After entering the "hour" with the procedure in ① and ②, enter the "minute" using the same procedure.

4 Enter the OFF time.

- ① Set the timer OFF time by rotating the "multi control" knob.

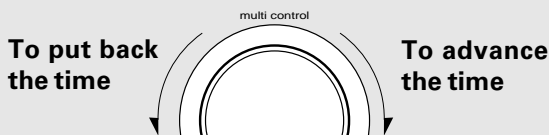

- ② Press the "enter" key.

- ③ After entering the "hour" with the procedure in ① and ②, enter the "minute" using the same procedure.

5 Make the desired reservation.

For timer playback or AI timer playback

- ① Rotate the "multi control" knob to select the timer mode.

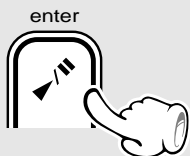
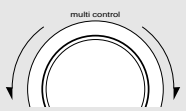

- ① Select "PLAY" or "AI PLAY".
- ▶ **PLAY**..... Timer play
 - ▶ **REC**
 - ▶ **AI PLAY**... Timer play with gradually increasing volume

- ② Press the "enter" key.



- ① ON time setting



Blinks

- If you make a mistake in the middle, press the "mode" key to cancel the operation and restart it from step ②.

- ① OFF time setting



Blinks

- If you make a mistake in the middle, press the "mode" key to cancel the operation and restart it from step ②.

Timer recording of radio broadcasts

- ① Rotate the "multi control" knob to select the record mode.

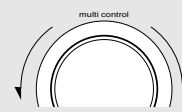

Select "REC".

- ▶ **PLAY**
- ▶ **REC**
- ▶ **AI PLAY**

Press the "enter" key.

- ② Select the input source.

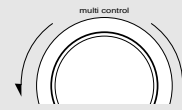

Select the source to be recording.

- ▶ **TUNER**
- ▶ **AUX**

Press the "enter" key.

Continued on next page

Continued on next page

2 Select the input source.

- 1 Select the source to be played.

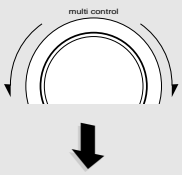

TUNER
CD
MD
TAPE
AUX

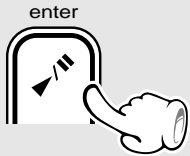

- 2 Press the "enter" key.

SOURCE
TUNER

3 Select the broadcast station (only when TUNER is selected).

- 1 Select the preset station No.

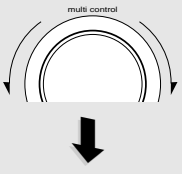

- 2 Press the "enter" key.

F103
106.00MHz

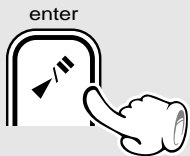

COMPLETE

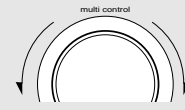
3 Select the broadcast station (only when TUNER is selected).

Select the preset station No.

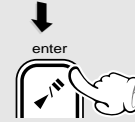

Press the "enter" key.

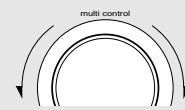
4 Select the recording unit.

TAPE
MD

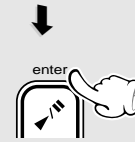

Press the "enter" key.

- With timer recording of radio broadcasting, the audio is muted automatically at the moment the power is switched ON by the timer.

6 Set the program.

- 1 Press the "TIMER" key on the remote control unit to select "PROG.1".

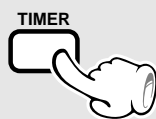

- 2 Press the "POWER" key to switch the power OFF (standby). (The "standby/timer" indicator lights in green.)

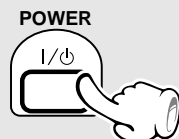
**7** Timer execution

Lights

- The timer does not operate when no program is set.



- The reservation contents cannot be cleared. The contents are cleared only when they are changed.
- If the "standby/timer" indicator blinks in green while the power is in the off (STANDBY) mode, the timer program cannot be executed.

Now the program timer reservation is complete. Use the same procedure as above when you want to reserve a program timer operation in PROG.2.

Ensure that the power is OFF.

To cancel execution of a timer program (Remote control unit only)

Press the "TIMER" key repeatedly until "PROG.1" or "PROG.2" disappears.

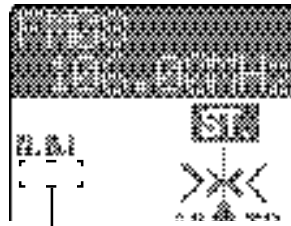
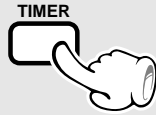

Goes off

- The reservation contents are held in memory.

To set the same timer program again (Remote control unit only)

Press the "TIMER" key repeatedly until "PROG.1" or "PROG.2" appears.

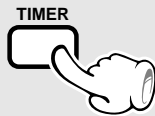

Lights

- Also prepare the disc or tape and adjust the listening volume.

Sleep timer

The sleep timer is used to set the period after which the power will switch OFF automatically.

While the power is ON (in a play mode)

Press the "SLEEP" key on the remote control unit.



- Each press increases the set time by 10 minutes. The sleep timer can be set up to about 90 minutes.

10 → 20 70 → 80 → 90 → Cancel → 10 → 20

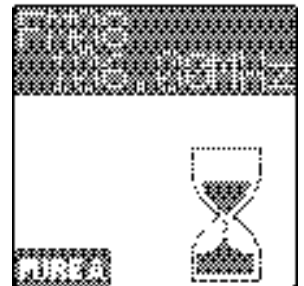
**To cancel**

Turn the power OFF or press the "SLEEP" key until the sleep time is cancelled.

The system has been set so that the LCD brightness drops automatically during the sleep timer operation. (Auto dimmer)

Handling of discs and tapes

Disc handling precautions

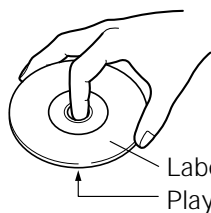

Handling

Hold the discs so that you do not touch the playing surface.

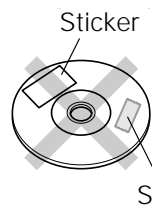

Do not attach paper or tape to either the playing side or the label side of the discs.

Sticky paste

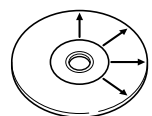

Cleaning

If fingerprints or foreign matter become attached to the disc, lightly wipe the disc with a soft cotton cloth (or similar) from the center of the disc outwards in a radial manner.

Storage

When a disc is not to be played for a long period of time, remove it from the player and store it in its case.

Discs which can be played with this unit

CD (12 cm, 8 cm), and the audio part of CDV, CD-G, CD-EG and CD-EXTRA.

Use discs that comply with the IEC standard, for example a disc carrying the  marking on the label surface.

Never play a cracked or warped disc

During playback, the disc rotates at high speed in the player.

Therefore, to avoid danger, never use a cracked or deformed disc or a disc repaired with tape or adhesive agent. Please do not use discs which are not round because they may cause a malfunction.

Disc accessories

The disc accessories (stabilizer, protection sheet, protection ring, etc.) which are marketed for improving the sound quality or protecting discs as well as the disc cleaner should not be used with this system because they may cause malfunction.

Maintenance of the unit

When the front panel or case becomes dirty, wipe with a soft, dry cloth. Do not use thinner, benzene, alcohol, etc. for these agents may cause discoloration.

In regard to contact cleaner

Do not use contact cleaners because it could cause a malfunction. Be specially careful not to use contact cleaners containing oil, for they may deform the plastic component.

Cleaning the CD insertion slot

Insertion slot and its surroundings

The CD insertion slot should be cleaned because it tends to collect dust.

If a CD is inserted while dust is accumulated around the insertion slot, the disc may be damaged.

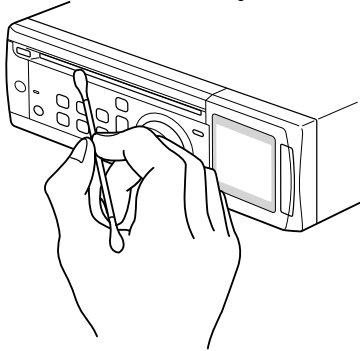

Cleaning the head section

Head demagnetization

When the record and play heads are magnetized, noise in the audio may become loud. To prevent this, demagnetize the heads using a commercially available head demagnetizer (head cleaner) which often has the shape of a tape cassette.

Head cleaning

To use the cassette deck in the best condition for a long period, it is recommended to clean the heads (record/play/erase), capstans and pinch rollers every 10 hours of tape playback.

They can be cleaned using a commercially available head demagnetizer (head cleaner) which often has the shape of a tape cassette.

Notes on cassette tape

Safety tab (accidental erasure prevention tab)

After an important recording has been finished, break the safety tab, to prevent the recorded contents from being erased or recorded on accidentally.

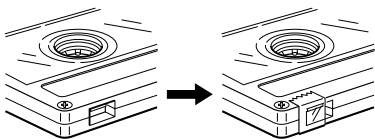
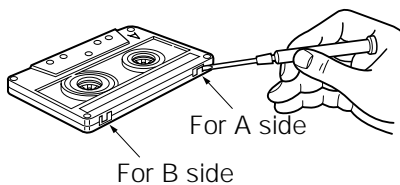

To re-record Apply tape only to the position where the tab has been removed.
(Press firmly to make it stick so that it does not peel off.)

To store cassette tapes

Do not store the tapes in a place which is subject to direct sunlight, or near equipment that generates heat. Keep the cassette tapes away from any magnetic field.

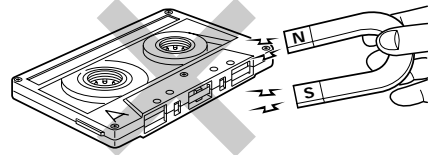

When there is slack in the tape

In such a case, insert a pencil into the reel hole and wind the reel hub to remove the slack.

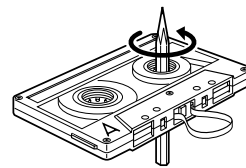

1. Longer tape than 100 minutes cassette tape

Since longer tape than 100 minutes cassette tape is very thin, the tape could adhere to the pinch roller or be easily cut. It is recommended that these tapes not be used with this unit to prevent possible damage.

2. Endless tapes

Do not use an endless tape, as this could damage the mechanism of the unit.

3. Regarding labels peeling off

If labels or adhesive tape stuck to a cassette tape peel off, they may cause a malfunction. Only continue using the cassette tape after reapplying the label or adhesive tape firmly.

Precautions and Notes

Dolby noise reduction manufactured under license from Dolby Laboratories. "DOLBY" and the double-D symbol are trademarks of Dolby Laboratories.

Note related to transportation and movement

Before transporting or moving this unit, carry out the following operations.

1. Switch the power ON.
2. Select the CD input, wait for a few seconds and ensure that the LCD becomes as shown in the figure below. If a disc is left in the CD player, press the "▲ eject" key to eject it.

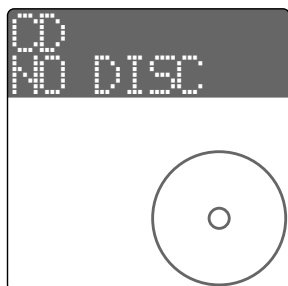

3. Turn the power OFF.

Memory backup function

<p>Stored contents which are cleared immediately when power plug is unplugged from power outlet</p>	<p>Clock display</p>
<p>Stored contents which are cleared in at least a day after power plug is unplugged from power outlet</p>	<p>POWER status (ON or OFF) Input selection Volume control value Receiving band Frequency Preset stations Program settings</p>

WARNING NOTICE:

IN MOST CASES IT IS AN INFRINGEMENT OF COPYRIGHT TO MAKE COPIES OF TAPES OR DISCS WITHOUT THE PERMISSION OF THE COPYRIGHT OWNERS. ANYONE WISHING TO COPY COMMERCIALY AVAILABLE TAPES OR DISC SHOULD CONTACT THE MECHANICAL COPYRIGHT PROTECTION SOCIETY LIMITED OR THE PERFORMING RIGHTS SOCIETY LIMITED.

What appears to be a malfunction may not always be serious. If your unit should not perform as expected, consult the table below to see if the problem can be corrected before seeking help from your dealer or service representative.

Operation to reset

The microcomputer may fall into malfunction (impossibility to operate, erroneous display, etc.) when the power cord is unplugged while power is ON or due to an external factor. In this case, execute the following procedure to reset the microcomputer and return it to normal condition.

- Please note that resetting the microcomputer clears the contents stored in it returns it to condition when it left the factory.

RD-VH7

Unplug the power cord from the wall AC outlet and, while holding the "■ stop" key depressed, plug the power cord again.

- If a CD has been loaded in the unit, it will be ejected automatically.

X-VH7















Unplug the power cord from the AC outlet and, while holding the "▲ eject" key depressed, plug the power cord again.

- If a tape is loaded in the deck, it will be ejected now.

Amplifier-tuner/CD player, speakers

Symptom	Cause	Remedy
Sound is not produced.	<ul style="list-style-type: none"> ● The speaker cords are disconnected. ● The volume control is set to the minimum position. ● The MUTE switch of remote control unit is switched ON. ● The headphone plug is inserted into the jack. 	<ul style="list-style-type: none"> ● Connect properly referring to → 15 "Connection of speakers". ● Adjust to an required volume. → 22 ● Switch MUTE OFF. → 23 ● Unplug the headphone plug. → 23
The "standby" indicator blinks in red.	<ul style="list-style-type: none"> ● The speaker cords are short-circuited. 	<ul style="list-style-type: none"> ● Turn the power OFF, remove the short-circuit and turn the power ON again. → 15
The "standby" indicator blinks in green.	<ul style="list-style-type: none"> ● The timer is set without adjusting the clock. 	<ul style="list-style-type: none"> ● Be sure to perform the "clock adjustment" operation before setting the timer. → 21
Sound is not produced from the left or right speakers.	<ul style="list-style-type: none"> ● The speaker cords are disconnected. 	<ul style="list-style-type: none"> ● Connect properly referring to → 15 "Connection of speakers".
The clock display blinks without changing the figures.	<ul style="list-style-type: none"> ● There was a power failure. ● The power cord was unplugged from the outlet. 	<ul style="list-style-type: none"> ● Adjust the present time again. → 21 ● Adjust the present time again. → 21
Demonstration starts suddenly.	<ul style="list-style-type: none"> ● The power cord was unplugged and plugged again or there was a power failure. 	<ul style="list-style-type: none"> ● This is not a malfunction. Press the "auto/mono, demo" key to switch the demonstration OFF. → 4
Timer operation is not possible.	<ul style="list-style-type: none"> ● The present time has not been adjusted or there was a power failure. ● The timer ON time and OFF time have not been set. ● The timer execution was not set up. 	<ul style="list-style-type: none"> ● Adjust the present time referring to "Clock adjustment". → 21 ● Set the timer ON time and OFF time. → 51 ● Press the "TIMER" key to set up the execution. → 53
The power turns OFF suddenly.	<ul style="list-style-type: none"> ● The "A.P.S." (Auto Power Save) function is activated. 	<ul style="list-style-type: none"> ● Cancel the "A.P.S.". → 25
The LCD display is invisible or hard to read.	<ul style="list-style-type: none"> ● The contrast is set to minimum. 	<ul style="list-style-type: none"> ● Press and hold the "mode" key for more than 2 seconds. (This resets the contrast to the initial value.) → 25



Amplifier-tuner/CD player, speakers

Symptom	Cause	Remedy
Radio stations cannot be received.	<ul style="list-style-type: none"> ● The antennas have not been connected. ● A proper broadcasting band has not been selected. ● The frequency of the station to be received is not tuned. 	<ul style="list-style-type: none"> ● Connect antennas. →  12 ● Select a band. →  34 ● Tune to the frequency of the desired station. →  34
Noise interferes with radio reception.	<ul style="list-style-type: none"> ● Car ignition noise. ● Influence of an electric appliance. ● A TV set is installed near the system. 	<ul style="list-style-type: none"> ● Install the outdoor antenna in an apart position from the road. →  12 ● Switch the suspected electric appliance OFF. ● Install the TV or the system at an increased distance between them.
Preset call operation cannot receive a radio station which has been preset.	<ul style="list-style-type: none"> ● The frequency of the preset station is not tunable. ● The preset memory has been cleared because the power cord has been unplugged for a long period. 	<ul style="list-style-type: none"> ● Preset stations with tunable frequencies. →  35 ● Preset stations again. →  35
A CD is placed in the player but it cannot be played.	<ul style="list-style-type: none"> ● The disc is placed upside down. ● The disc is extremely dirty. ● The disc is scratched. ● Dew is condensed on the optics lens. 	<ul style="list-style-type: none"> ● Place the disc properly, with the label side facing upward. →  26 ● Clean the disc referring to "Disc handling precautions". →  55 ● Try another disc. ● Refer to "Caution on condensation" and remove the condensation by evaporation. →  57
Even when the "▲ eject" key is pressed, "PLEASE WAIT" is displayed and the disc will not be ejected.		<ul style="list-style-type: none"> ● Wait until "PLEASE WAIT" disappears, then press the "▲ eject" key.
Sound is not produced.	<ul style="list-style-type: none"> ● The disc has not been placed. ● The player is not put to the play mode. ● The disc is extremely dirty. ● The disc is scratched. 	<ul style="list-style-type: none"> ● Place a disc in the CD player. →  26 ● Press the "▶/ " key. →  27 ● Clean the disc referring to "Disc handling precautions". →  55 ● Try another disc.
Sound skips.	<ul style="list-style-type: none"> ● The disc is dirty. ● The disc is scratched. ● The player is subject to vibration. 	<ul style="list-style-type: none"> ● Clean the disc referring to "Disc handling precautions". →  55 ● Try another disc. ● Install the unit in a place not subject to vibrations.
A played disc is damaged.	<ul style="list-style-type: none"> ● Dust is accumulated on the CD insertion slot. ● Burr is left on the outer or inner edge of the disc. 	<ul style="list-style-type: none"> ● Clean the CD insertion slot and the surroundings. →  56 ● Do not use a burred disc.

Cassette deck unit

Symptom	Cause	Remedy
Sound cannot be produced by pressing the play key or no operation occurs even when an operation key is pressed.	<ul style="list-style-type: none"> ● The head is dirty. ● The tape is wound too tight due to irregular winding. ● A nonrecorded tape is played. 	<ul style="list-style-type: none"> ● Clean the head referring to "Head cleaning". → 56 ● Try another tape. ● Play a recorded tape.
No operation occurs even when an operation key is pressed.	<ul style="list-style-type: none"> ● The operation key is pressed in less than 4 seconds after turning the power ON. ● A tape is not inserted in the unit. ● The tape is wound too tight due to irregular winding. ● The tape is fully wound to one of the reels. 	<ul style="list-style-type: none"> ● Press operation keys after waiting for more than 4 seconds. ● Insert a tape. ● Try another tape. ● Change the tape transport direction or reverse the tape insertion orientation. → 41
The DPSS malfunctions.	<ul style="list-style-type: none"> ● The tape used is not suitable for DPSS, for example the spaces between tunes may be too short. 	<ul style="list-style-type: none"> ● Refer to "Notes". → 43
Sound is harsh or high frequencies are not reproduced.	<ul style="list-style-type: none"> ● The head is dirty. ● The tape is stretched or shrunk. 	<ul style="list-style-type: none"> ● Clean the head referring to "Head cleaning". → 56 ● Try another tape.
Sound is distorted.	<ul style="list-style-type: none"> ● The recording level has not been set with the "crls" key. ● The tape being played was recorded with distorted sound. 	<ul style="list-style-type: none"> ● Refer to "Automatic Adjustment of the Recording Level (crls)". → 46 ● Try another tape.
Noise is noticeable.	<ul style="list-style-type: none"> ● The tape head is magnetized. ● External noise is induced. ● A tape recorded with Dolby NR ON is played with Dolby NR OFF. 	<ul style="list-style-type: none"> ● Demagnetize the head referring to "Head demagnetization". → 56 ● Install the system at a distance from other electric appliances and TV. ● Set the Dolby NR to on. → 41
Sound fluctuates.	<ul style="list-style-type: none"> ● The capstans or pinch rollers are dirty. ● The tape is wound irregularly. 	<ul style="list-style-type: none"> ● Clean the head referring to "Head cleaning". → 56 ● Wind the tape again by fast forwarding, rewinding or playing from an end to the other. → 41
Recording cannot be started by pressing the "● rec/arm" key.	<ul style="list-style-type: none"> ● The recording protect tab of the cassette has been broken. ● The TAPE input is selected. ● The tape is fully wound to one of the reels. 	<ul style="list-style-type: none"> ● Use a cassette with an unbroken recording protect tab or block the hole. → 56 ● Select the source to be recorded with the "input" key. → 44 ● Change the tape transport direction or reverse the tape insertion orientation. → 41

Remote control unit

Symptom	Cause	Remedy
Remote control operation is not possible.	<ul style="list-style-type: none"> ● Batteries are exhausted. ● The remote control is too far away from the system, the controlling angle is deviated or there is an obstacle in between. ● There is no tape or CD set in the component to be played. ● An attempt is made to play the cassette deck which is recording something. 	<ul style="list-style-type: none"> ● Replace with new batteries. →  ● Operate the unit inside the remote controllable range. →  ● Set a tape or CD in the component to be played. ● Wait until the recording ends.



1. With some tapes, a squeaky noise is produced when the tape is stopped automatically. This is due to the tape protection function, and not a malfunction.
2. Do not use longer than 100 minutes tapes, for the tape is too thin and gets easily tangled.

Amplifier-tuner/CD player (RD-VH7)

(For U.S.A.)

[Amplifier section]

Rated output power

15 watts per channel minimum RMS, both channels driven, at 6 Ω, 60 Hz to 20,000 Hz with no more than 0.9 % total harmonic distortion. (FTC)

Total harmonic distortion 0.05 % (1 kHz, 10 W, 6 Ω)
 Frequency response
 Line (AUX, TAPE, MD) 20 Hz ~ 50 kHz, +0 dB, -3 dB
 Signal to noise ratio
 Line (AUX, TAPE, MD) 93 dB (IHF'66)
 Output level / Impedance
 SUPER WOOFER PRE OUT 2.0 V / 1 kΩ

[FM Tuner section]

Tuning frequency range 87.5 MHz ~ 108 MHz
 Usable sensitivity (MONO at 75 Ω)
 2.0 μV / 17.2 dBf (75 kHz dev., SINAD, 30 dB)
 Signal to noise ratio (at 1 kHz, 75 kHz Dev.)
 MONO 70 dB (65 dBf input)
 STEREO 65 dB (65 dBf input)
 Stereo separation (1 kHz) 38 dB
 Frequency response (100 Hz ~ 15 kHz)
 +0.5 dB, -3.0 dB

[AM Tuner section]

Tuning frequency range 530 kHz ~ 1700 kHz
 Usable sensitivity (30 % mod., S/N 20 dB)
 18 μV / (500 μV/m)
 Signal to noise ratio (at 30 % mod., 1 mV input)
 45 dB

(For U.K. and Europe)

[Amplifier section]

Effective output power (1 kHz, 10 %, 6 Ω) (RMS)
 20 W + 20 W
 Total harmonic distortion 0.05 % (1 kHz, 10 W, 6 Ω)
 Frequency response
 Line (AUX, TAPE, MD) ... 20 Hz ~ 50 kHz / +0 dB, -3 dB
 Signal to noise ratio
 Line (AUX, TAPE, MD) 93 dB (IHF'66)
 Output level / Impedance
 SUPER WOOFER PRE OUT 2.0 V / 1 kΩ

[FM Tuner section]

Tuning frequency range 87.5 MHz ~ 108 MHz
 Usable sensitivity (DIN at 75 Ω)
 MONO 1.6 μV / 14.2 dBf (40 kHz dev., S/N 26 dB)
 Signal to noise ratio (DIN weighted / unweighted at 1 kHz)
 MONO 65 dB (40 kHz dev., 65.2 dBf input)
 STEREO 59 dB (40 kHz dev., 65.2 dBf input)
 Stereo separation (DIN) (1 kHz) 36 dB
 Selectivity (DIN± 300 kHz) 64 dB
 Frequency response (100 Hz ~ 15 kHz)
 +0.5 dB, -3.0 dB

[AM Tuner section]

Tuning frequency range 531 kHz ~ 1602 kHz
 Usable sensitivity (30 % mod., S/N 20 dB)
 18 μV / (700 μV/m)
 Signal to noise ratio (at 30 % mod., 1 mV input)
 45 dB



1. KENWOOD follows a policy of continuous advancements in development. For this reason specifications may be changed without notice.
2. Sufficient performance may not be possible at very low temperatures (0°C or less).

[CD player section]

Laser	Semiconductor laser
Playing rotation	200 rpm ~ 500 rpm (CLV)
Frequency response	4 Hz ~ 20 kHz
Signal to noise ratio	More than 96 dB
Total harmonic distortion	Less than 0.01 % (at 1 kHz)
Wow & Flutter	Unmeasurable Limit
Digital output	
Optical	-15 dBm ~ -21 dBm (wave length 660 nm)

[General]

Power consumption	60 W
Dimensions	
(Horizontal installation)	W: 247 mm (9-3/4 in.) H: 96 mm (3-3/4 in.) D: 291 mm (11-7/16 in.)
Weight (net)	4.0 kg (8.8 lb)

Cassette deck (X-VH7)

Track	4-track, 2-channel stereo
Recording system	AC bias system (Frequency: 105 kHz)

Heads

Playback / recording head	1
Erasing head	1

Motors

Wow and flutter

Fast winding time

Frequency response

TYPE I tape

TYPE II tape

Signal to noise ratio (CrO₂ tape)

Dolby NR OFF

Dolby B NR ON

Dolby C NR ON

Input sensitivity / Impedance

Output level / Impedance

General

Power consumption

Dimensions

(Horizontal installation)

H: 96 mm (3-3/4 in.)

D: 279 mm (11 in.)

Weight (net)



1. KENWOOD follows a policy of continuous advancements in development. For this reason specifications may be changed without notice.
2. Sufficient performance may not be possible at very low temperatures (0°C or less).

KENWOOD

For your records

Record the serial number, found on the back of the unit, in the spaces designated on the warranty card, and in the space provided below. Refer to the model and serial numbers whenever you call upon your dealer for information or service on this product.

Model _____ Serial Number _____